

C-FCU2T202402

2024



Midea Building Technologies Division
Midea Group

Add.: Midea Headquarters Building, 6 Midea Avenue, Shunde, Foshan, Guangdong, China
Postal code: 528311

mbt.midea.com www.midea-group.com tsp.midea.com

Midea reserves the right to change the specifications of the product, and to withdraw or replace products without prior notification or public announcement. Midea is constantly developing and improving its products.



MAKE A BEAUTIFUL TOMORROW

Midea Fan Coil Units
AC FCU / DC FCU

Midea MBT

Midea MBT(Midea Building Technologies) is a key division of the Midea Group, a leading provider of comprehensive solutions of intelligent building, involving energy sources, elevators, control systems, and heating, ventilation & air conditioning. Midea MBT has continued with the tradition of innovation upon which it was founded and emerged as a global leader in the HVAC and building management industry. A strong drive for advancement has resulted in an extensive R&D department that has placed Midea MBT at the forefront of a competitive -edge. Through these independent projects and joint-cooperation with other global enterprises, Midea has supplied thousands of innovative solutions to customers worldwide.

Several production bases are situated on Shunde, Chongqing, Hefei, and Italy.

MBT Shunde: 38 product lines focusing on VRF, Split Products, Heat Pump Water Heaters and AHU/FCU.

MBT Chongqing: 14 product lines focusing on Water Cooled Centrifugal/Screw/Scroll Chillers, Air Cooled Screw/Scroll Chillers and AHU/FCU.

MBT Hefei: 11 product lines focusing on VRF, Chillers and Heat Pump Water Heaters.

Clivet S.p.A: 50,000m2 workshop in Feltre and Verona, covering products such as ELFO system, hydronic, WHLP, packaged, split and close control and so on.





MBT Learning Academy

Objective

MBT Learning Academy aims to provide training to the sales personnel as well as technical personnel in order to increase the utilization for your MBT equipment. Once you have purchased equipment from MBT, taking care of the equipment is topmost priority. MBT Learning Academy offers training courses to learn firsthand from the manufacturer what it takes to get the best out of your MBT product. The goal of MBT Learning Academy is to provide product specific training, safe work procedures and expertise in carrying out the installation and maintenance of MBT products as well as teaching the main selling points in order to help the sales people sell the MBT products with ease.

Training Centers

Our world class training centers provide knowledge and skills necessary to efficiently deploy MBT technologies. The training centers include dedicated laboratories to provide hands-on experiences with various systems, components and controls to refresh and enhance the skills of your sales, design and installation and service teams. Right now we operate our trainings from the below two locations:

1. MBT Training Center

Address: MBT Training Center, 2nd Floor, Building 6, Midea Global Innovation Center, Beijiao, Shunde, Foshan, China Pin-528311

The Midea MBT Training Center is situated 70 kilometers from Baiyun Guangzhou International Airport.

Products: VRF, M thermal

2. Chongqing Midea Training Center

Address: No. 15, Qiangwei Road, Nan'an District, Chongqing, China

Chongqing Midea Training Center is 35 kilometers from Chongqing International Airport.

Products: Centrifugal Chiller, Screw/Scroll Chiller and Terminals



VRF training



M thermal training



Chiller training

Global Technical Trainings

The training courses by MBT Learning Academy are divided into the following two categories with different targeted audiences for each.

Design and Application Trainings: The design and application trainings for various products are basically for the sales personnel selling MBT products in order to give them basic understanding about the main features. The trainings are conducted on a global level inviting sales engineers, technical engineers, consultants and project designers from different parts of the world.

After Sales- Service Trainings: These trainings are dedicated for the After Sales/ Service personnel in order for them to better carry out the installation, commissioning and maintenance of MBT products. Technical person and engineers from different parts of the world are invited to take part in these trainings.

Online Trainings: The trainings to the Global customers can also be done online with the help of Team and Midea Meeting software. This way, the customers do not need to be physically present for the training. Amid the COVID-19 pandemic, MBT Learning Academy has conducted a lot of online trainings. The training videos are available on the TSP system and can be downloaded by using QR codes.

Products: VRF, M thermal, Chillers and Terminals

Highly Skilled Trainers: The trainers for various courses by MBT Learning Academy are expert people with vast experiences in their field. Most of them have a deep insight about the global HVAC market and help the attendees to better understand the MBT products.

Training Certificates:

The attendees for Global trainings are provided a training certificate highlighting the courses discussed in the training, signed by Mr. Henry Cheng, General Manager of MBT Overseas Sales Company.

Registration:

You can contact your respective Midea contact point to provide you with the complete schedule about the global technical trainings as well as how to register for these trainings.

For further enquiries about the Global Trainings conducted by MBT Learning Academy, please send email at the following email address: peeyush@midea.com



Chiller After Sales Courses



Chiller Introduction Courses

Midea Global Spare Parts Center

The global spare parts center provides high quality and fast spare parts supply. Midea online system (<https://tsp.midea.com>) can query and purchase spare parts with one click, further shortening the supply time of spare parts.

The “**2** (HQ Spare parts center) + **10** (Regional Spare parts center) + **N** (Country Spare parts inventory)” Spare Parts Layout can ensure the timely supply of global after-sales spare parts.



Technical Support Platform (TSP)

TSP is a platform for customers to provide professional technical support. Through TSP, you can inquire product information, documentation, spare parts and troubleshooting, initiate technical questions and quality complaint process, and also support self-service spare parts order.

APAC: <https://ics.midea.com/>
EMEA: <https://ics-eu.midea.com/>
Americas: <https://ics-amer.midea.com/>



My order

Inquire spare parts from exploded view and place spare parts order directly in TSP.

Document inquiry and download

View or download product technical documentation online, such as catalogs, images, training PPTs, etc.

Technical inquiry & FAQ

Initiate technical questions online, and our technicians answer them online in time. Find a quick solution in the FAQ.

Troubleshooting

Query the error code and solution by SN, model name, error code or product type.

Complain

Initiate the product quality complaint process online, and our after-sales engineers handle related complaints in time.

Mobile Intelligence Service App (MISA)

MISA is the mobile terminal of TSP, with the same functions as TSP. The mobile service makes technical support more timely and convenient.

<https://link.midea.com>



FAQ



Complain



Technical Enquiry



Trouble shooting

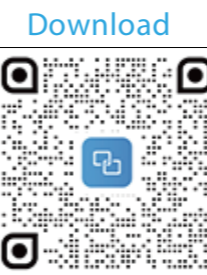

Scan above to download the mobile app

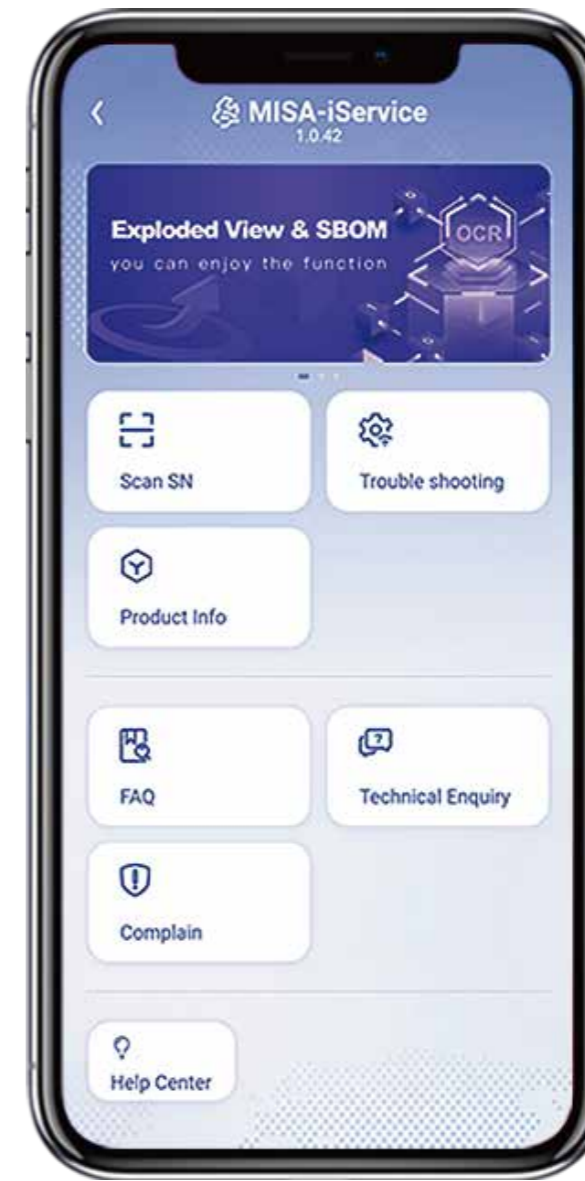

Search product manuals



Spare Parts list

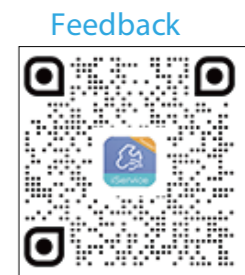

Thank you very much for your attention and advice

Contents

- ▶ 11 Reference Projects
- ▶ 15 AC Fan Coil Units
- ▶ 56 DC Fan Coil Units
- ▶ 92 Dimensions
- ▶ 105 Control Solutions

Introduction

Midea fan coil units are divided into ceiling exposed type, ceiling concealed type, wall-mounted type and floor-standing type according to their structure, design and installation method. The air volume ranges from 150CFM to 2200CFM (255m³/h~3740m³/h). It is a highly versatile product suitable for hospitals, office buildings, hotels, airports and various other applications.

Reference Projects

2018 Russia World Cup Stadiums Nizhny Novgorod Stadium

- 📍 City: Nizhny Novgorod
- 🏗️ Product: Water-cooled Screw Chiller; Fan Coil Units

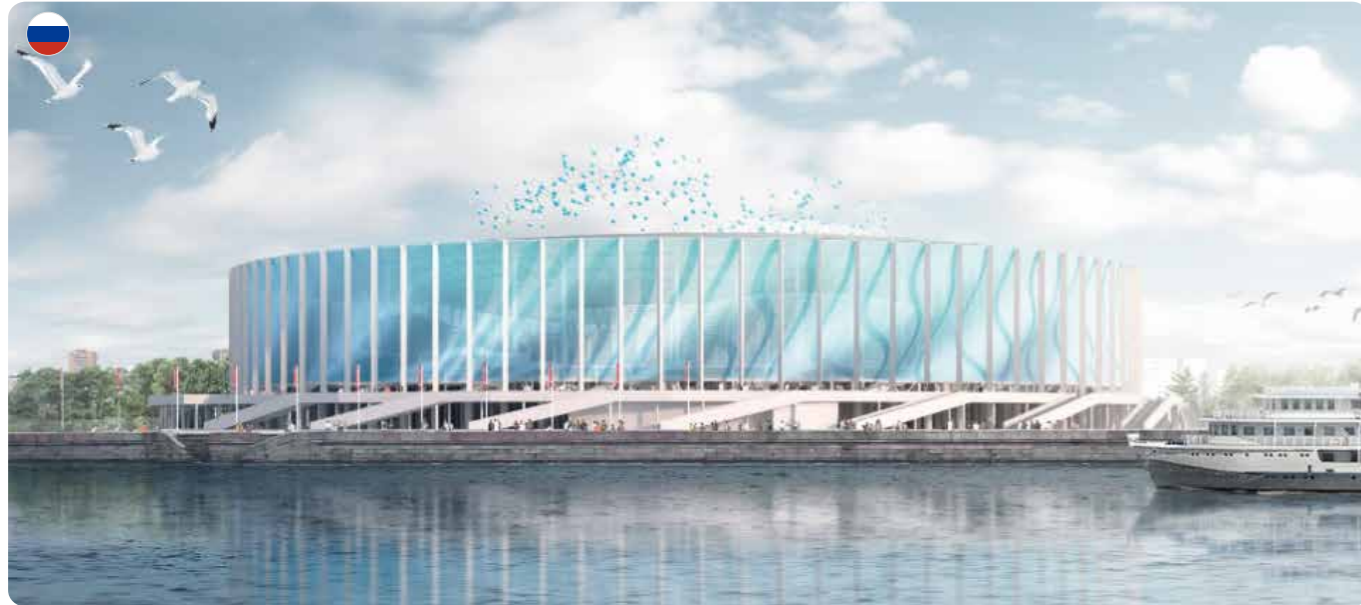

2018 Russia World Cup Stadiums Volgograd Arena

- 📍 City: Volgograd
- 🏗️ Product: Water-cooled Screw Chiller; Fan Coil Units



The 27th Southeast Asian Games Stadium

- 📍 Country: Myanmar
- 📍 City: Nay Pyi Taw
- 🏗️ Outdoor Units: Water-cooled screw chiller
- 🏗️ Indoor Units: MAHU
- 👤 Total Capacity: 4,100RT



Beijing New International Airport

- 📍 Country: China
- 📍 City: Beijing
- 🏗️ Outdoor Units: Centrifugal chiller
- 🏗️ Indoor Units: FCU & MAHU
- 👤 Total Capacity: 10,000RT



Hilton Hotel in Foshan(Five Star)

- 🌐 Country: China
- 📍 City: Foshan
- 🏢 Outdoor Units: Centrifugal chiller & Water-cooled screw chiller
- 🏠 Indoor Units: FCU & AHU
- 📊 Total Capacity: 4,500RT



Top Glove in Malaysia

- 🌐 Country: Malaysia
- 📍 City: Klang
- 🏢 Outdoor Units: Water-cooled screw chiller
- 🏠 Indoor Units: FCU & AHU
- 📊 Total Capacity: 3,400RT



Major Platinum Cineplex Laos

- 🌐 Country: Laos
- 📍 City: Vientiane
- 🏢 Outdoor Units: Centrifugal chiller & Water-cooled screw chiller
- 🏠 Indoor Units: FCU & AHU
- 📊 Total Capacity: 2,000RT



The Prime Minister Office Building

- 🌐 Country: Tajikistan
- 📍 City: Dushanbe
- 🏢 Outdoor Units: Water-cooled screw chiller
- 🏠 Indoor Units: FCU & AHU
- 📊 Total Capacity: 2,880kW





AC Fan Coil Units





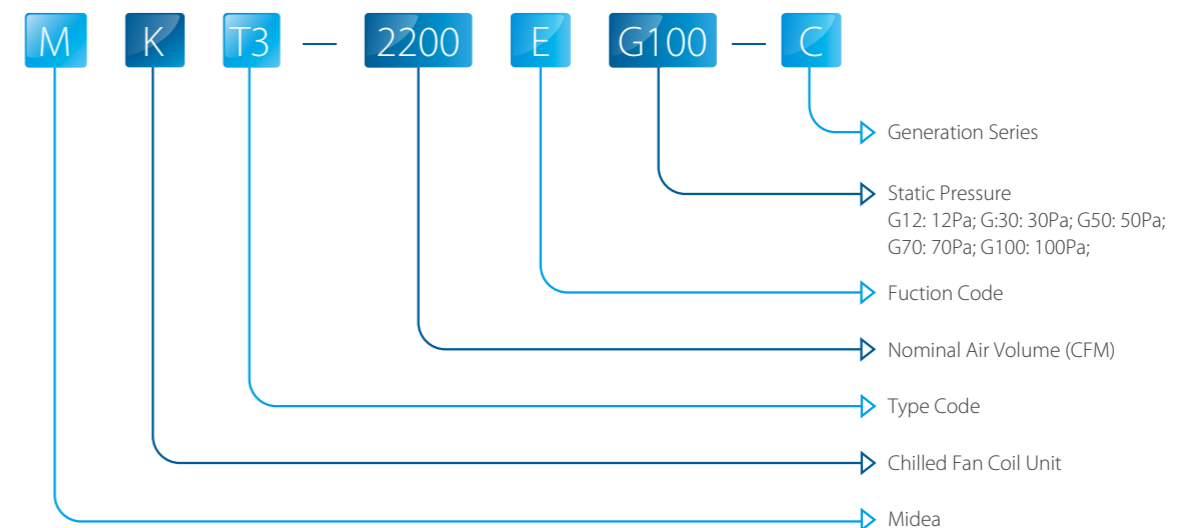

Midea Fan Coil Units have ceiling exposed type, ceiling concealed type, wall-mounted type and floor-standing type. The air volume ranges from 150CFM to 2200CFM. It is a highly versatile product suitable for hospitals, office buildings, hotels, airports and various other applications.

Nomenclature





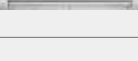

Product Lineup

2-Pipe FCUs

Model		150	200	250	300	350	400	450	500	600		700	750	800	850	900	950	1000	1200	1400	1500	1600	1800	2000	2200
1-way cassette					⊙		⊙																		
4-way cassette										⊙		⊙		⊙		⊙		⊙			⊙				
Compact 4-way cassette					⊙		⊙		⊙																
Duct			⊙		⊙		⊙		⊙	⊙		⊙		⊙				⊙	⊙	⊙		⊙	⊙	⊙	
High static pressure Duct														⊙				⊙	⊙	⊙		⊙	⊙		⊙
Wall mounted				⊙	⊙		⊙		⊙	⊙															
2 nd generation Ceiling&floor		⊙		⊙		⊙			⊙			⊙		⊙											

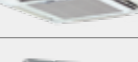
4-Pipe FCUs

Model		100	150	200	250	300	350	400	450		500	600	700	750	800	850	900	950	1000	1200	1400	1500	
Compact 4-way cassette						⊙		⊙			⊙												
4-way cassette												⊙		⊙		⊙		⊙			⊙		⊙
Duct				⊙		⊙		⊙			⊙	⊙			⊙				⊙	⊙	⊙		
2 nd generation Ceiling&floor			⊙		⊙		⊙				⊙		⊙		⊙								

Notes:
The standard power supply for all fan coil units is 220V-240V/50Hz; 208-230V/60Hz can be customized for some series of fan coil units, for further information, please contact with our salesmen.

AC Series Functions

Functions			One-way Cassette	Compact Four-way Cassette	Four-way Cassette	Wall Mounted	2nd Generation Ceiling & Floor	Medium Static Pressure Duct	High Static Pressure Duct
Control Customization	Follow me	With the follow me function, the indoor unit responds to the temperature measured by the temperature sensor built-in the wireless remote controller.	○(KJR-29B)	○(KJR-29B)	○(KJR-29B)	○(KJR-29B)	×	×	×
	Anti cold air	Prevent the unit from cold supply air when starting in winter.	●	●	●	●	×	×	×
	Auto-restart	The unit restarts automatically with the previous settings after power failure.	●	●	●	●	×	×	×
	Forced fan running	After reaching the set temperature, the valve body closes and the fan operates according to the set logic.	○	√	√	√	×	×	×
	Heat	Only electric auxiliary heating.	×	√	√	√	×	×	×
	Temperature compensation	Heating mode: $T_2=T_1+\Delta T$; Cooling mode: $T_2=T_1-\Delta T$ T2: Indoor Temperature, T1: Setting Temperature, ΔT : Temperature Compensation	○	√	√	√	×	×	×
	XYE Port	Communicate with central controllers or BMS.	○(NIM-01)	●	●	●	○(FCU-kit)	○(FCU-kit)	○(FCU-kit)
	PQE Port	Communicate with Modbus.	×	○	○	○	×	×	×
	CCM18/CCM08/ CCM15/BMS/IMM	Central controllers and BMS.	○	●	●	●	○(FCU-kit)	○(FCU-kit)	○(FCU-kit)
	0-10V output control	By outputting a 0-10 V level, the opening of the valve body is controlled to meet different energy requirements.	×	○	○	○	×	×	×
0-10V input control	By inputting a 0- 10 V level to PCB, the fan motor speed is controlled to meet different energy requirements.	×	×	×	×	×	×	×	
Structure Customization	Right/Left piping connection	Left and right hand piping connections are optional, flexible installation.	×	×	×	×	●	●	●
	Electric auxiliary heating	Increase heating capacity with additional electric heater.	×	○	○	○	×	○	○
	Extended drainage pan	Drainage pan accessory.	×	×	×	×	×	○	×
	Auxiliary drainage pan		×	○	○	×	○	○	×

Note:
 ●: equipped as standard; ○: customization option; ×: without this function; √: switch setting

One-way Cassette



Model: 300/400 CFM



RM05 Standard



KJR-75A Optional

Features

- The central controller can be connected through the customized Network Module MD-NIM01.
- Remote on/off function can be applied to turn on/off the unit.
- Wired controller KJR-75A is optional.
- Compact design, ultra slim body with a minimum thickness of 153mm.
- Standard built-in drain pump with 750mm pump head.

One way cassette has a compact size, it's suitable for application in narrow space such as the aisle, small office, elevator space etc.



Multiple Fan Speeds

The AC Series comes with 3 fan speed option to meet the needs of different indoor conditions.

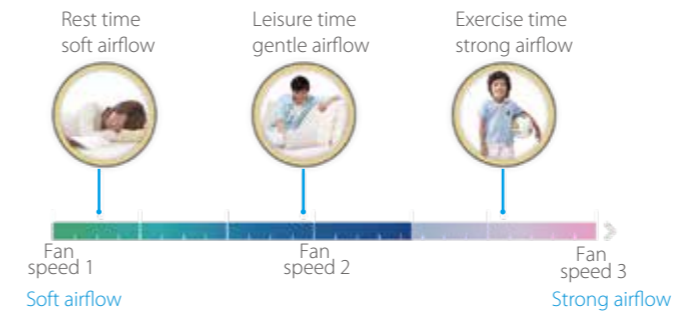

One Direction Air Flow

One direction air flow guarantees quick cooling, flexible installation positioning.

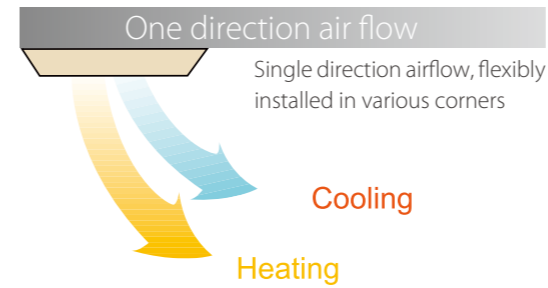

Control solutions

The fan coil units can be connected to Midea central controllers or BMS through the customized network module MD-NIM01.

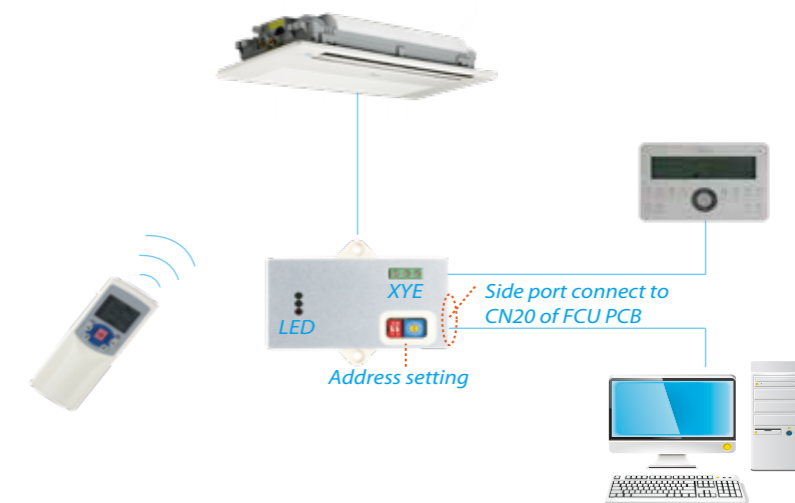

High-lift Pump

Standard built-in drain pump with 750mm pump head.

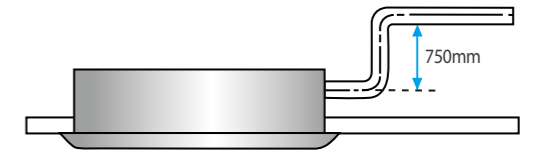

Minimum 153 mm thickness

Compact design, ultra slim body with a minimum thickness of 153mm, especially suitable for narrow ceiling, such as in lobbies and small meeting rooms.



Auto restart

In the event of a sudden power failure during operation, unit restarts automatically and the unit will operate based on the previous setting (operating mode, temperature setting and fan speed).

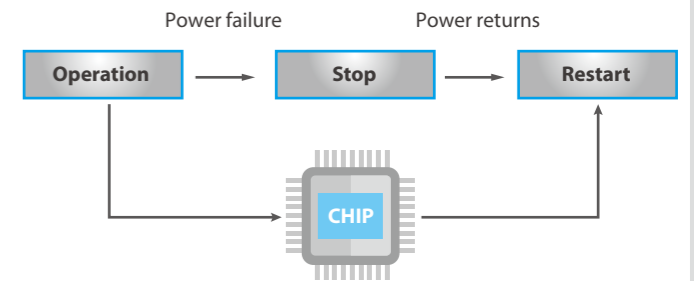

Specifications

Model			MKC-300R-B	MKC-400R-B
Power supply		V/Ph/Hz	220-240/1/50	
Air flow (H/M/L)		m ³ /h	510/450/400	630/560/500
		CFM	300/270/240	370/330/300
Cooling	Capacity (H/M/L)	kW	3.04/2.79/2.56	3.79/3.58/3.38
	Water flow rate	m ³ /h	0.52/0.48/0.44	0.65/0.62/0.58
	Water pressure drop	kPa	14.00/11.85/9.88	20.00/17.67/15.84
Heating	Capacity (H/M/L)	kW	5.13/4.69/4.04	6.41/5.86/5.11
	Water flow rate	m ³ /h	0.52/0.48/0.44	0.65/0.62/0.58
	Water pressure drop	kPa	14.00/11.85/9.88	20.00/17.67/15.84
Power input (H/M/L)		W	32/22/15	40/30/25
Sound pressure level (H/M/L)		dB(A)	36/34/32	37/35/34
Fan motor	Type		Low noise 3-speed fan motor	
	Quantity		1	1
Fan	Type		Centrifugal, forward-curved Blades	
	Quantity		1	1
Coil	Row		2	2
	Max. working pressure	MPa	1.6	1.6
	Diameter	mm	Ø7	Ø7
Panel	Net dimensions (WxHxD)		1180x25x465	1180x25x465
	Packing size (WxHxD)		1232x107x517	1232x107x517
	Net weight		3.5	3.5
	Gross weight		5.2	5.2
Body	Net dimensions (WxHxD)		1054x153x428	1054x153x428
	Packing size (WxHxD)		1155x245x490	1155x245x490
	Net weight (non-AEH/with-AEH)		12.8/13.1	12.8/13.1
	Gross weight (non-AEH/with-AEH)		16.6/17.1	16.6/17.1
Pipe connections	Water inlet/outlet pipe		G1/2	G1/2
	Drain pipe		ODØ25	ODØ25

Notes:

1. H: High fan speed; M: Medium fan speed; L: Low fan speed.
2. Cooling conditions: Entering water 7°C, leaving water 12°C, Entering air temperature 27°C DB/19°C WB.
Heating conditions: Entering water 45°C, leaving water 40°C, Entering air temperature 20°C DB/15°C WB.
3. Noise is tested in a semi-anechoic test room.
4. Auxiliary electric heater (AEH) is optional.

Four-way Cassette

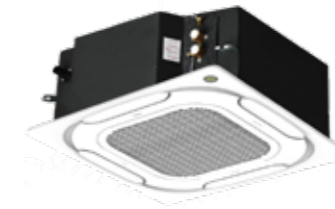

Model: 600/750/850/950/1200/1500 CFM

R05
StandardKJR-29B
Optional

Features

- 4-way air supply panel as standard, new 360° air supply panel is optional.
- Built-in PCB and drain pump with pump head-750mm.
- Remote controller with LED display is standard, wired controller is optional.
- Safety grill for safety maintenance.
- Optional extended drainage pan for protecting your ceiling better.
- Compatible with 0-10V control function.
- Available for 2/4 pipe system.
- Auxiliary electric heater (AEH) is optional (for 2-Pipe 4-Way Cassette).

360° airflow for immediate, equal distribution of wider-angle cooling and heating, ideal for standard ceilings.



Stylish Panel with Large Airflow Outlet

4-way air supply panel is standard for 4-way cassette.

360° air supply panel is standard for compact 4-way cassette.

4-way panel



360° panel



NEW 360° panel

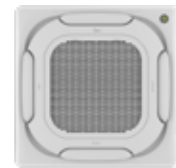

NEW 360° panel

New design, round air flow path ensures uniform air flow and temperature distribution.

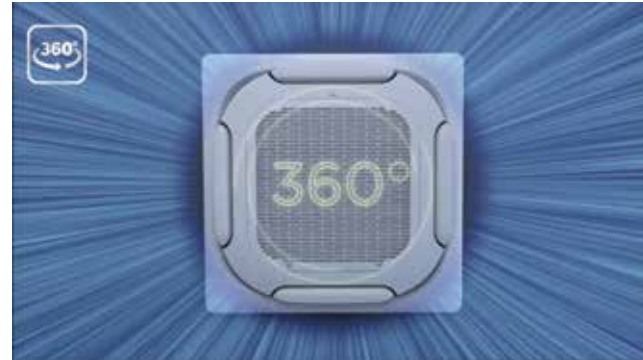

Individual louver control

The Individual louver control can control the motors separately, making it possible to control all four louvers independently.



Auto restart

In the event of a sudden power failure during operation, unit restarts automatically and the unit will operate based on the previous setting (operating mode, temperature setting and fan speed).

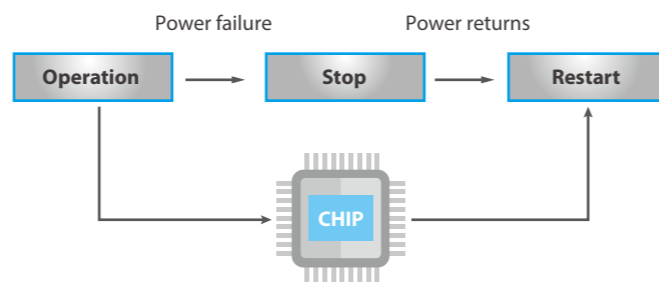

Various Selections

Versions for normal size.

The height of models 600 to 750 is just 230mm whilst models 850 to 1500 is 300mm, making the Four-way Cassette ideal for standard ceilings.

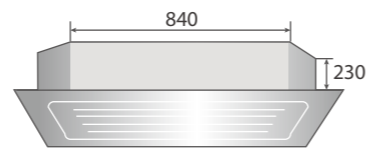

High-lift Drain Pump

A drain pump with a 750mm pump head is fitted as standard, simplifying installation of the drain piping.

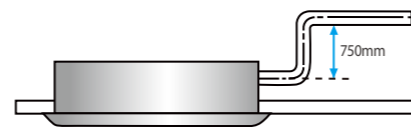

Control solutions

The fan coil units can be connected to Midea central controllers through the customized XYE port, also can be connected to Modbus gateway through the customized PQE port with Modbus RTU protocol.



2-Pipe 4-Way Cassette

Model		MKA-600R	MKA-750R	MKA-850R	
Power supply	V/ph/Hz	220-240/1/50			
Air flow (H/M/L)	m ³ /h	1000/850/720	1250/1060/900	1400/1190/1010	
	CFM	590/500/420	740/620/530	820/700/590	
Cooling	Capacity (H/M/L)	kW	5.7/4.73/3.96	7.27/6.46/5.71	
	Water flow rate	m ³ /h	1.03/0.88/0.76	1.20/0.96/0.80	1.28/1.15/1.02
	Water pressure drop	kPa	24.3/18.2/13.9	30.0/20.1/15.00	24.4/20.2/16.0
Heating	Capacity (H/M/L)	kW	9.66/7.72/6.27	11.55/9.24/7.51	12.42/9.93/8.07
	Water flow rate	m ³ /h	1.20/1.02/0.85	1.95/1.55/1.23	1.43/1.28/1.10
	Water pressure drop	kPa	29.5/21.7/15.6	37.2/23.4/18.4	28.3/22.8/17.2
Power input (H/M/L)	W	125/84/74	130/102/93	150/124/106	
Auxiliary electric heater (AEH)	W	2100	2100	2850	
Sound pressure level (H/M/L)	dB(A)	45/41/36	46/42/37	47/43/38	
Fan motor	Type	Low noise 3-speed fan motor			
	Quantity	1	1	1	
Fan	Type	Centrifugal, forward-curved blades			
	Quantity	1	1	1	
Coil	Row	2	2	2	
	Max. working pressure	MPa	1.6	1.6	1.6
Panel	Diameter	mm	Φ7	Φ7	
	Net dimensions (W×H×D)	mm	950×45×950	950×45×950	950×45×950
	Packing size (W×H×D)	mm	1035×90×1035	1035×90×1035	1035×90×1035
	Net weight	kg	6	6	6
	Gross weight	kg	9	9	9
Body	Net dimensions (W×H×D)	mm	840×230×840	840×230×840	840×300×840
	Packing size (W×H×D)	mm	900×260×900	900×260×900	900×330×900
	Net weight (non-AEH/with-AEH)	kg	25/27	25/27	30.5/33
	Gross weight (non-AEH/with-AEH)	kg	30/32	30/32	36.2/39
Pipe connections	Water inlet/outlet pipe	inch	RC3/4	RC3/4	RC3/4
	Drain pipe	mm	ODΦ32	ODΦ32	ODΦ32

Model		MKA-950R	MKA-1200R	MKA-1500R	
Power supply	V/ph/Hz	220-240/1/50			
Air flow (H/M/L)	m ³ /h	1600/1360/1150	2000/1700/1440	2550/2170/1840	
	CFM	940/800/680	1180/1000/850	1500/1280/1080	
Cooling	Capacity (H/M/L)	kW	8.22/7.39/6.54	10.39/9.25/8.2	12.9/11.51/10.21
	Water flow rate	m ³ /h	1.41/1.27/1.12	1.80/1.60/1.40	2.20/1.90/1.80
	Water pressure drop	kPa	27.14/21.98/18.05	22.00/17.00/14.10	40.00/27.20/25.00
Heating	Capacity (H/M/L)	kW	13.85/11.08/9	17.58/14.06/11.42	17.6/14.08/11.44
	Water flow rate	m ³ /h	2.35/1.80/1.53	2.97/2.35/1.94	2.90/2.38/1.90
	Water pressure drop	kPa	31.65/26.19/22.08	28.1/20.7/17.4	50.0/35.0/25.0
Power input (H/M/L)	W	155/131/106	190/127/109	190/136/109	
Auxiliary electric heater (AEH)	W	2850	2850	/	
Sound pressure level (H/M/L)	dB(A)	48/44/39	49/45/40	50/46/41	
Fan motor	Type	Low noise 3-speed fan motor			
	Quantity	1	1	1	
Fan	Type	Centrifugal, forward-curved blades			
	Quantity	1	1	1	
Coil	Row	2	2	3	
	Max. working pressure	MPa	1.6	1.6	1.6
Panel	Diameter	mm	Φ7	Φ7	
	Net dimensions (W×H×D)	mm	950×45×950	950×45×950	950×45×950
	Packing size (W×H×D)	mm	1035×90×1035	1035×90×1035	1035×90×1035
	Net weight	kg	6	6	6
	Gross weight	kg	9	9	9
Body	Net dimensions (W×H×D)	mm	840×300×840	840×300×840	840×300×840
	Packing size (W×H×D)	mm	900×330×900	900×330×900	900×330×900
	Net weight (non-AEH/with-AEH)	kg	30.5/33	30.5/33	31.8
	Gross weight (non-AEH/with-AEH)	kg	36.2/39	36.2/39	36
Pipe connections	Water inlet/outlet pipe	inch	RC3/4	RC3/4	RC3/4
	Drain pipe	mm	ODΦ32	ODΦ32	ODΦ32

Notes:

1. H: High fan speed; M: Medium fan speed; L: Low fan speed.
2. Cooling conditions: Entering water 7°C, leaving water 12°C, Entering air temperature 27°C DB/19°C WB.
Heating conditions: Entering water 50°C, the same water flow as the cooling conditions, Entering air temperature 20°C DB.
3. Noise is tested in a semi-anechoic test room.
4. Auxiliary electric heater (AEH) is optional.

4-Pipe 4-Way Cassette

Model			MKA-600F	MKA-750F	MKA-850F
Power supply		V/Ph/Hz		220-240/1/50	
Air flow (H/M/L)		m ³ /h	1150/800/690	1460/1020/880	1480/1040/890
		CFM	680/470/410	860/600/510	870/610/520
Cooling	Capacity (H/M/L)	kW	5.1/4.08/3.76	5.93/4.41/3.94	6.17/5.13/4.59
	Water flow rate	m ³ /h	0.87/0.64/0.53	0.97/0.69/0.57	1.06/0.90/0.79
	Water pressure drop	kPa	15.92/9/6.41	18.79/10.11/7.22	20.4/15.0/12.5
Heating	Capacity (H/M/L)	kW	6.67/5.87/5.07	7.87/6.85/5.9	8.06/6.93/6.05
	Water flow rate	m ³ /h	0.52/0.4/0.34	0.6/0.44/0.38	0.7/0.6/0.55
	Water pressure drop	kPa	24.56/14.60/10.61	33.96/18.52/13.99	44.98/35.00/28.10
Power input (H/M/L)		W	170/120/85	188/135/90	198/140/100
Sound pressure level (H/M/L)		dB(A)	42/32/26	44/34/28	46/36/30
Fan motor	Type		Low noise 3-speed fan motor		
	Quantity		1	1	1
Fan	Type		Centrifugal, forward-curved Blades		
	Quantity		1	1	1
Coil	Row		2	2	2
	Max. working pressure	MPa	1.6	1.6	1.6
	Diameter	mm	Φ7	Φ7	Φ7
Panel	Net dimensions (W×H×D)	mm	950×45×950	950×45×950	950×45×950
	Packing size (W×H×D)	mm	1035×90×1035	1035×90×1035	1035×90×1035
	Net weight	kg	6	6	6
	Gross weight	kg	9	9	9
Body	Net dimensions (W×H×D)	mm	840×300×840	840×300×840	840×300×840
	Packing size (W×H×D)	mm	900×330×900	900×330×900	900×330×900
	Net weight	kg	35	35	35
	Gross weight	kg	41	41	41
Pipe connections	Water inlet/outlet pipe	inch	Cold water: RC3/4; Hot water: RC1/2		
	Drain pipe	mm	ODΦ32	ODΦ32	ODΦ32

Model			MKA-950F	MKA-1200F	MKA-1500F
Power supply		V/Ph/Hz		220-240/1/50	
Air flow (H/M/L)		m ³ /h	1720/1200/1030	1860/1300/1110	2100/1470/1260
		CFM	1010/700/610	1090/760/650	1230/860/740
Cooling	Capacity (H/M/L)	kW	6.7/5.48/4.85	9.28/7.45/6.5	10.58/7.45/6.5
	Water flow rate	m ³ /h	1.15/0.95/0.83	1.60/1.30/1.10	2.10/1.90/1.60
	Water pressure drop	kPa	35.0/20.0/15.0	40.0/35.0/30.0	43.31/38.03/32.44
Heating	Capacity (H/M/L)	kW	8.67/7.63/6.59	11.65/10.49/8.85	12.62/11.36/9.47
	Water flow rate	m ³ /h	0.75/0.67/0.60	1.00/0.92/0.80	1.50/0.99/0.86
	Water pressure drop	kPa	43.91/33.59/29.43	52.91/42.36/36.00	56.13/46.89/38.90
Power input (H/M/L)		W	205/145/105	197/135/103	234/165/115
Sound pressure level (H/M/L)		dB(A)	47/38/32	48/40/34	50/42/36
Fan motor	Type		Low noise 3-speed fan motor		
	Quantity		1	1	1
Fan	Type		Centrifugal, forward-curved Blades		
	Quantity		1	1	1
Coil	Row		2	3	3
	Max. working pressure	MPa	1.6	1.6	1.6
	Diameter	mm	Φ7	Φ7	Φ7
Panel	Net dimensions (W×H×D)	mm	950×45×950	950×45×950	950×45×950
	Packing size (W×H×D)	mm	1035×90×1035	1035×90×1035	1035×90×1035
	Net weight	kg	6	6	6
	Gross weight	kg	9	9	9
Body	Net dimensions (W×H×D)	mm	840×300×840	840×300×840	840×300×840
	Packing size (W×H×D)	mm	900×330×900	900×330×900	900×330×900
	Net weight	kg	35	38	38
	Gross weight	kg	41	44	44
Pipe connections	Water inlet/outlet pipe	inch	Cold water: RC3/4; Hot water: RC1/2		
	Drain pipe	mm	ODΦ32	ODΦ32	ODΦ32

Notes:

1. H: High fan speed; M: Medium fan speed; L: Low fan speed.
2. Cooling conditions: Entering water 7°C, leaving water 12°C, Entering air temperature 27°C DB/19°C WB.
Heating conditions: Entering water 70°C, leaving water 60°C, Entering air temperature 20°C DB.
3. Noise is tested in a semi-anechoic test room.

Compact Four-way Cassette



Model: 300/400/500 CFM

R51
StandardKJR-29B
Optional

Features

- 360° air supply panel is standard.
- Built-in PCB and drain pump with pump head-500mm.
- Remote controller with LED display is standard, wired controller is optional.
- Safety grill for safety maintenance.
- Optional extended drainage pan for protecting your ceiling better.
- Compatible with 0-10V control function.
- Available for 2/4 pipe system.
- Auxiliary electric heater (AEH) is optional (for 2-Pipe Compact 4-Way Cassette).

Compact design allows installation in shallow ceilings.



360° Airflow

360° air outlets of the Compact Four-way Cassette provide strong airflow circulation to cool or heat every corner of a room and evenly control temperature.

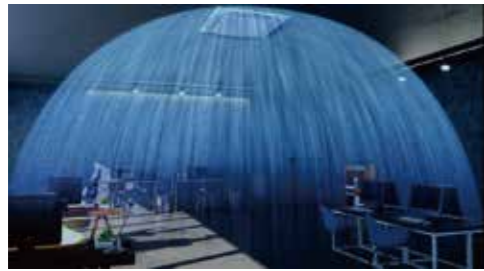

Multiple Fan Speeds

The AC Series comes with 3 fan speed option to meet the needs of different indoor conditions.

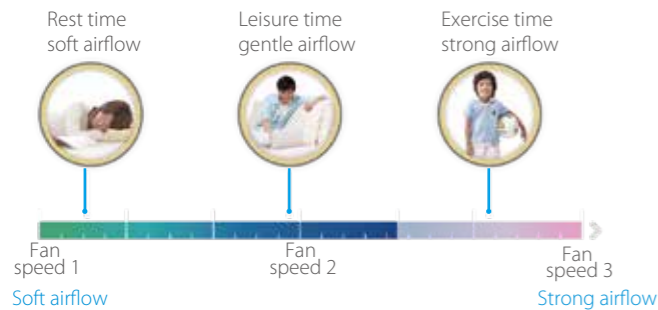

High-lift Drain Pump

A drain pump with a 500mm pump head is fitted as standard, simplifying installation of the drain piping.

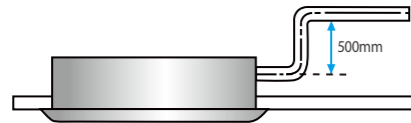

Auto restart

In the event of a sudden power failure during operation, unit restarts automatically and the unit will operate based on the previous setting (operating mode, temperature setting and fan speed).

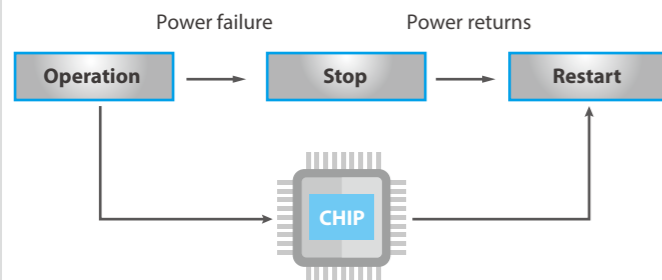

Control solutions

The fan coil units can be connected to Midea central controllers through the customized XYE port, also can be connected to Modbus gateway through the customized PQE port with Modbus RTU protocol.

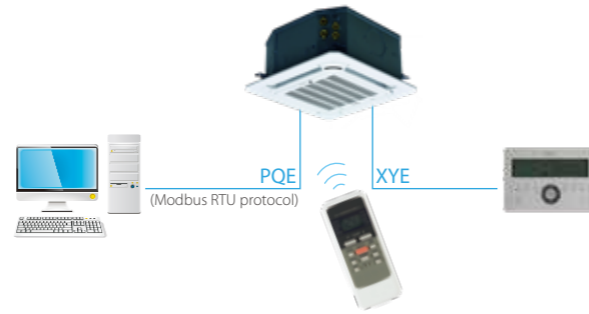

Compact design

The height of models 300 to 500 is just 261mm, making the Compact Four-way Cassette ideal for standard ceilings.

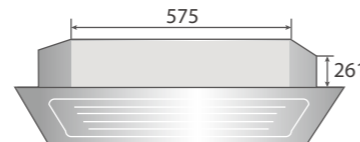

Compact Four-way Cassette body dimension is only 575 mm x 575 mm which can easily fits into less to 585 mm ceiling grid.

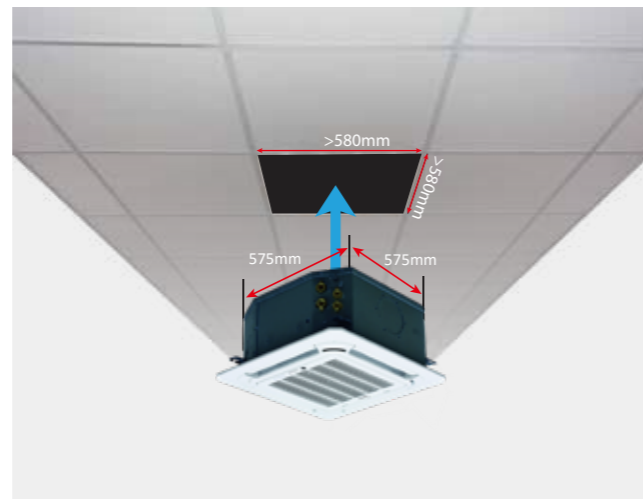

2-Pipe Compact 4-Way Cassette

Model		MKD-300	MKD-400	MKD-500
Power supply		V/Ph/Hz		220-240/1/50
Air flow (H/M/L)		m³/h	510/440/360	680/580/480
		CFM	300/260/210	400/340/280
Cooling	Capacity (H/M/L)	kW	3/2.58/2.16	3.7/3.18/2.66
	Water flow rate	m³/h	0.52/0.42/0.34	0.63/0.54/0.45
	Water pressure drop	kPa	10.70/9.11/7.15	20.00/15.00/10.00
Heating	Capacity (H/M/L)	kW	4/3.5/3.08	5.1/4.3/3.83
	Water flow rate	m³/h	0.68/0.60/0.52	0.82/0.70/0.65
	Water pressure drop	kPa	15.4/15.0/10.0	22.0/17.0/15.2
Power input (H/M/L)		W	50/40/30	70/50/40
Auxiliary electric heater (AEH)		W	1000	1000
Sound pressure level (H/M/L)		dB(A)	36/33/28	42/39/32
Fan motor	Type	Low noise 3-speed fan motor		
	Quantity	1	1	1
Fan	Type	Centrifugal, forward-curved Blades		
	Quantity	1	1	1
Coil	Row	2	2	2
	Max. working pressure	MPa	1.6	1.6
	Diameter	mm	Φ7	Φ7
Panel	Net dimensions (WxHxD)	mm	647x50x647	647x50x647
	Packing size (WxHxD)	mm	715x123x715	715x123x715
	Net weight	kg	2.6	2.6
	Gross weight	kg	4.7	4.7
Body	Net dimensions (WxHxD)	mm	575x261x575	575x261x575
	Packing size (WxHxD)	mm	670x290x670	670x290x670
	Net weight	kg	16.5	16.5
	Gross weight	kg	20	20
Pipe connections	Water inlet/outlet pipe	inch	G3/4	G3/4
	Drain pipe	mm	ODΦ25	ODΦ25

4-Pipe Compact 4-Way Cassette

Model		MKD-300S	MKD-400S	MKD-500S
Power supply		V/Ph/Hz		220-240/1/50
Air flow (H/M/L)		m³/h	510/440/360	680/580/480
		CFM	300/260/210	400/340/280
Cooling	Capacity (H/M/L)	kW	2.5/2.2/1.76	2.9/2.55/2.04
	Water flow rate	m³/h	0.43/0.38/0.30	0.50/0.44/0.35
	Water pressure drop	kPa	22.00/17.04/10.90	16.00/12.39/7.84
Heating	Capacity (H/M/L)	kW	3.7/3.29/2.92	4.6/3.82/3.4
	Water flow rate	m³/h	0.32/0.28/0.25	0.40/0.33/0.29
	Water pressure drop	kPa	17.00/13.47/10.61	23.00/16.23/12.59
Power input (H/M/L)		W	50/40/30	70/50/40
Sound pressure level (H/M/L)		dB(A)	36/33/28	42/39/32
Fan motor	Type	Low noise 3-speed fan motor		
	Quantity	1	1	1
Fan	Type	Centrifugal, forward-curved Blades		
	Quantity	1	1	1
Coil	Row	2	2	2
	Max. working pressure	MPa	1.6	1.6
	Diameter	mm	Φ7	Φ7
Panel	Net dimensions (WxHxD)	mm	647x50x647	647x50x647
	Packing size (WxHxD)	mm	715x123x715	715x123x715
	Net weight	kg	2.6	2.6
	Gross weight	kg	4.7	4.7
Body	Net dimensions (WxHxD)	mm	575x261x575	575x261x575
	Packing size (WxHxD)	mm	670x290x670	670x290x670
	Net weight	kg	16.5	16.5
	Gross weight	kg	20	20
Pipe connections	Water inlet/outlet pipe	inch	Cold water: G3/4; Hot water: G1/2	
	Drain pipe	mm	ODΦ25	ODΦ25

Notes:

1. H: High fan speed; M: Medium fan speed; L: Low fan speed.
2. Cooling conditions: Entering water 7°C, leaving water 12°C, Entering air temperature 27°C DB/19°C WB.
Heating conditions: Entering water 70°C, leaving water 60°C, Entering air temperature 20°C DB.
3. Heating mode(2): (2-pipe coil): entering air temperature 20°C DB, enter water teperature/water flow 50°C/*(same water flow as in standard rating condition in cooling)
4. Noise is tested in a semi-anechoic test room.

Duct series



Model: 200/300/400/500/600/700/800/1000/1200/1400CFM

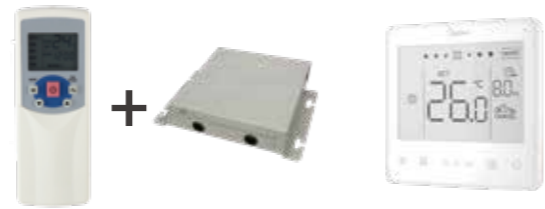

RM05+FCU KIT
Optional

KJRP-86I/MFK-E (Optional)
KJRP-86I/MFKS-E (Optional)
KJRP-86A/BMFNKD-E (Optional)

Features

- 3 or 4 row for 2-pipe system and 3 row for 4-pipe system.
- Versions for standard, A4 and large difference temperature type.
- Washable filter: Iron frame filter is standard, and aluminum frame filter can be customized. For district cooling duct, aluminum frame filter is standard.
- Compatible with two types of air return: Back return is standard, bottom return is optional.
- Left or right hand piping connections are easily change in filed.
- AEH is optional (for 3-Row, 4-Row Duct).

Slim, compact design for limited space with duct distribution to the indoor space.



Flexible Installation

Left and right hand piping connections are optional, flexible installation.

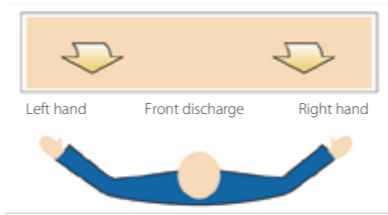

Compact Size

Min. height of 241mm, high, easy for limited space to installation.

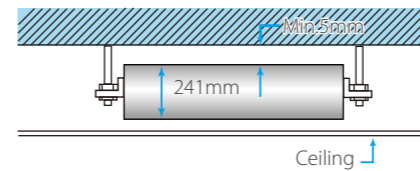

Flexible Air Inlet Port Installation

To provide the flexibility to adapt to differing installation situations, the air inlet may be positioned either on the underside or the rear of the unit.

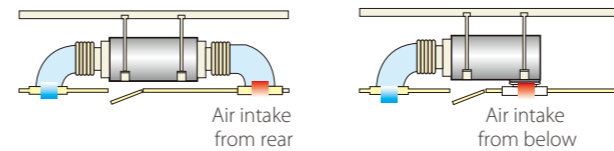

Extension water pan are optional to protect the ceiling from moisture.



Multiple Fan Speeds

The AC Series comes with 3 fan speed option to meet the needs of different indoor conditions.

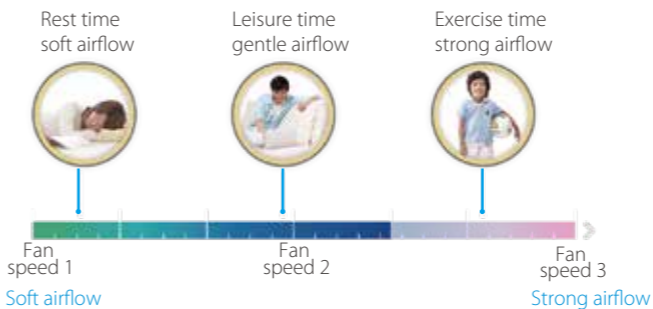

Control solutions

The duct series controlled by Wired controller, Central controller or BMS need to be customization FCU KIT.

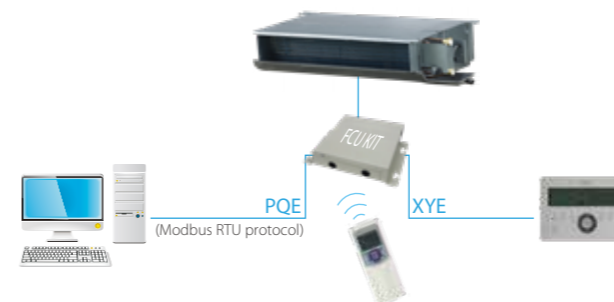

Washable filter

Iron frame filter is standard, and aluminum frame filter can be customized. For district cooling duct, aluminum frame filter is standard.

Air outlet flange and multi-direction pull-out filter can be customized.

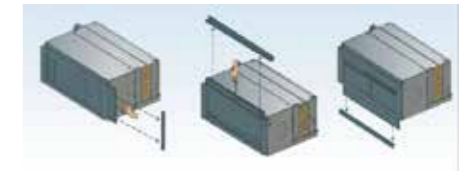

MK-CBS 3-row duct and district cooling duct

Meet with CE certification.

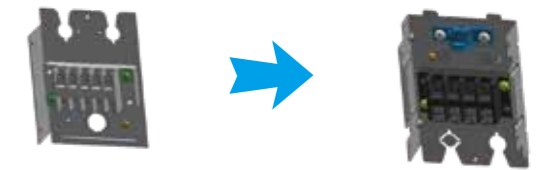

Flexible Installation

Left or right handed connection can be changed on site, including piping and wiring.

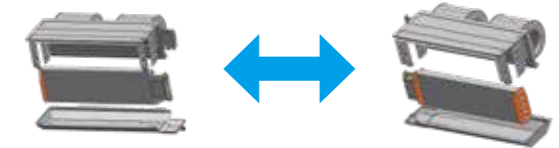

Deeper water tray

Deeper water tray to prevent excessive condensed water from overflow (incline installation or high air humidity) in extreme working conditions, which effectively improves the reliability.

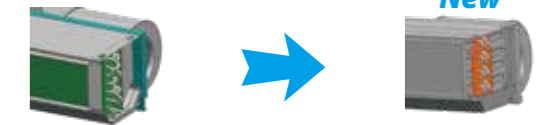

Easy to Pull Filter (District Cooling Duct)

Guide rail can be pulled left and right and the length of single piece filter is less than 600mm, so it is easy to take out the filter and convenient to maintain the unit. Up and down pull guide rail can be customized.

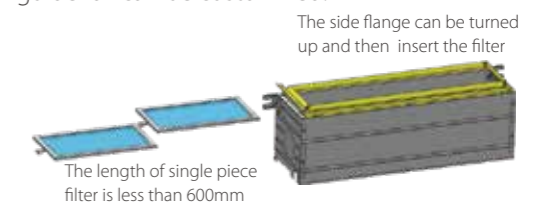

3-Row Duct

Model name		MKT3-200G12-CL	MKT3-300G12-CL	MKT3-400G12-CL	MKT3-500G12-CL	MKT3-600G12-CL
Power supply		V/Ph/Hz 220-240/1/50				
Air flow (H/M/L)	m³/h	340/257/172	510/384/256	680/516/344	850/643/429	1020/784/523
	CFM	200/151/101	300/226/151	400/303/202	500/379/252	600/461/308
Standard external static pressure		Pa 12 12 12 12 12				
Cooling	Capacity (H/M/L)	kW 2.35/2.00/1.50 3.40/2.90/2.21 4.41/3.77/2.90 5.00/4.27/3.36 6.00/5.16/4.06				
	Water flow rate (H/M/L)	m³/h 0.40/0.34/0.26 0.58/0.50/0.38 0.76/0.65/0.50 0.86/0.73/0.58 1.03/0.89/0.70				
	Water pressure (H/M/L)	kPa 24/20/15 24/19/14 24/21/16 30/23/18 38/28/25				
Heating	Capacity (H/M/L)	kW 3.90/3.09/2.15 5.67/4.52/3.18 7.35/5.89/4.19 8.60/6.93/5.03 9.98/8.14/5.96				
	Water flow rate (H/M/L)	m³/h 0.66/0.53/0.37 0.96/0.77/0.54 1.25/1.00/0.71 1.46/1.18/0.86 1.70/1.38/1.01				
	Water pressure (H/M/L)	kPa 20/16/12 20/16/12 20/17/13 24/19/15 31/23/20				
Power input (H/M/L)		W 36/25/23 50/28/23 60/47/39 74/69/53 93/68/56				
Auxiliary electric heater(AEH)		W 500 600 1000 1000 1500				
Current input (H/M/L)		A 0.16/0.11/0.10 0.23/0.13/0.10 0.27/0.21/0.18 0.34/0.31/0.24 0.42/0.31/0.25				
Sound pressure level (H/M/L)		dB(A) 35/26.5/23.5 39/27.5/26 41/30.5/24 43/34/28.5 45/36.6/31				
Fan motor	Type	Low noise 3-speed fan motor				
	Quantity	1 1 1 1 1				
Fan	Type	Centrifugal, forward-curved Blades				
	Quantity	1 2 2 2 2				
Coil	Row	3 3 3 3 3				
	MAX. working pressure	MPa 1.6 1.6 1.6 1.6 1.6				
	Diameter	mm 7 7 7 7 7				
Dimensions(WxHxD)		mm CB 632x243x482 773x243x482 908x243x482 908x243x482 1003x243x482				
Packing size(WxHxD)		mm CB 698x270x520 843x270x520 978x270x520 978x270x520 1073x270x520				
Net weight		kg CB 12.3 14.7 17.6 17.6 18.8				
Gross weight		kg CB 14.4 16.9 20.2 20.2 21.5				
Water inlet/outlet pipe		inch RC3/4 RC3/4 RC3/4 RC3/4 RC3/4				
Drain pipe		inch R3/4 R3/4 R3/4 R3/4 R3/4				

Notes:

1. H: High fan speed; M: Medium fan speed; L: Low fan speed;
2. Cooling conditions (H speed): water inlet 7°C, water outlet 12°C, entering air temperature 27°C DB/19.5°C WB, rated external static pressure;
3. Heating conditions (H speed): water inlet 60°C, entering air temperature 21°C DB/15°C, rated external static pressure. Water flow: same with cooling condition;
4. The above sound level is tested in the semi-anechoic room in accordance with GB/T19232 standard when the unit is without accessories and running in dry condition. The background noise is 17.5dB (A);
5. Air flow is tested when the unit is under rated external static pressure without return air box and filter screen in dry condition and 20°C DB;
6. "CC" means that the parameter is tested without air return box; "CB" means that the parameter is tested with air return box;
7. 30Pa is standard, 12Pa and 50Pa need to be customized;
8. Left and right unit can be changed in the field, but cooling and heating capacity should be multiplied with correction factor 0.9;
9. The performance data on above sheet was tested under 220V~50Hz;

3-Row Duct

Model name		MKT3-700G12-CL	MKT3-800G12-CL	MKT3-1000G12-CL	MKT3-1200G12-CL	MKT3-1400G12-CL
Power supply		V/Ph/Hz 220-240/1/50				
Air flow (H/M/L)	m³/h	1150/866/578	1360/1031/687	1650/1247/831	2040/1544/1029	2380/1785/1190
	CFM	677/510/340	800/607/404	971/734/489	1200/909/606	1400/1051/700
Standard external static pressure		Pa 12 12 12 12 12				
Cooling	Capacity (H/M/L)	kW 7.05/6.00/4.68 8.03/6.87/5.40 9.00/7.84/6.17 11.20/9.75/7.67 13.00/11.30/8.90				
	Water flow rate (H/M/L)	m³/h 1.21/1.03/0.80 1.38/1.18/0.93 1.55/1.35/1.06 1.93/1.68/1.32 2.24/1.94/1.53				
	Water pressure (H/M/L)	kPa 28/22/18 40/31/25 38/30/22 40/32/24 50/39/31				
Heating	Capacity (H/M/L)	kW 11.71/9.39/6.81 13.61/10.98/8.02 15.61/12.82/9.36 19.21/15.78/11.53 22.17/18.23/13.37				
	Water flow rate (H/M/L)	m³/h 1.99/1.60/1.16 2.31/1.87/1.36 2.65/2.18/1.59 3.27/2.68/1.96 4.62/3.10/2.27				
	Water pressure (H/M/L)	kPa 23/18/15 32/25/20 31/24/18 32/26/20 40/32/25				
Power input (H/M/L)		W 112/97/80 130/114/95 147/118/94 183/133/112 221/177/140				
Auxiliary electric heater(AEH)		W 1500 2000 2000 2500 2500				
Current input (H/M/L)		A 0.51/0.44/0.36 0.59/0.52/0.43 0.67/0.54/0.43 0.83/0.60/0.51 1.00/0.80/0.64				
Sound pressure level (H/M/L)		dB(A) 46/38/30 46/39.1/30 48/40.7/33 50/42.6/33 52/47.1/34				
Fan motor	Type	Low noise 3-speed fan motor				
	Quantity	1 1 1 2 2				
Fan	Type	Centrifugal, forward-curved Blades				
	Quantity	2 3 3 4 4				
Coil	Row	3 3 3 3 3				
	MAX. working pressure	MPa 1.6 1.6 1.6 1.6 1.6				
	Diameter	mm 7 7 7 7 7				
Dimensions(WxHxD)		mm CB 1178x243x482 1368x243x482 1368x243x482 1658x243x482 1898x243x482				
Packing size(WxHxD)		mm CB 1248x270x520 1438x270x520 1438x270x520 1728x270x520 1968x270x520				
Net weight		kg CB 21.4 25.5 26 33.8 35.3				
Gross weight		kg CB 24.5 29.1 29.7 39.5 39.8				
Water inlet/outlet pipe		inch RC3/4 RC3/4 RC3/4 RC3/4 RC3/4				
Drain pipe		inch R3/4 R3/4 R3/4 R3/4 R3/4				

Notes:

1. H: High fan speed; M: Medium fan speed; L: Low fan speed;
2. Cooling conditions (H speed): water inlet 7°C, water outlet 12°C, entering air temperature 27°C DB/19.5°C WB, rated external static pressure;
3. Heating conditions (H speed): water inlet 60°C, entering air temperature 21°C DB/15°C, rated external static pressure. Water flow: same with cooling condition;
4. The above sound level is tested in the semi-anechoic room in accordance with GB/T19232 standard when the unit is without accessories and running in dry condition. The background noise is 17.5dB (A);
5. Air flow is tested when the unit is under rated external static pressure without return air box and filter screen in dry condition and 20°C DB;
6. "CC" means that the parameter is tested without air return box; "CB" means that the parameter is tested with air return box;
7. 30Pa is standard, 12Pa and 50Pa need to be customized;
8. Left and right unit can be changed in the field, but cooling and heating capacity should be multiplied with correction factor 0.9;
9. The performance data on above sheet was tested under 220V~50Hz;

3-Row Duct

Model name		MKT3-200G30-CL	MKT3-300G30-CL	MKT3-400G30-CL	MKT3-500G30-CL	MKT3-600G30-CL	
Power supply	V/Ph/Hz	220-240/1/50					
Air flow (H/M/L)	m³/h	340/257/172	510/384/256	680/516/344	850/643/429	1020/784/523	
	CFM	200/151/101	300/226/151	400/303/202	500/379/252	600/461/308	
Standard external static pressure	Pa	30	30	30	30	30	
Cooling	Capacity (H/M/L)	kW	2.50/2.10/1.56	3.40/2.90/2.21	4.41/3.77/2.90	5.00/4.27/3.36	6.00/5.16/4.06
	Water flow rate (H/M/L)	m³/h	0.43/0.36/0.27	0.58/0.50/0.38	0.76/0.65/0.50	0.86/0.73/0.58	1.03/0.89/0.70
	Water pressure (H/M/L)	kPa	27/24/19	24/19/14	24/21/16	30/23/18	38/28/25
Heating	Capacity (H/M/L)	kW	4.10/3.20/2.20	5.67/4.52/3.18	7.35/5.89/4.19	8.60/6.93/5.03	9.98/8.14/5.96
	Water flow rate (H/M/L)	m³/h	0.70/0.54/0.37	0.96/0.77/0.54	1.25/1.00/0.71	1.46/1.18/0.86	1.70/1.38/1.01
	Water pressure (H/M/L)	kPa	22/20/16	20/16/12	20/17/13	24/19/15	31/23/20
Power input (H/M/L)	W	42/36/29	57/40/32	70/47/40	83/67/56	102/78/64	
Auxiliary electric heater(AEH)	W	500	600	1000	1000	1500	
Current input (H/M/L)	A	0.19/0.16/0.13	0.26/0.18/0.15	0.32/0.21/0.18	0.38/0.30/0.25	0.46/0.35/0.29	
Sound pressure level (H/M/L)	dB(A)	37/30/23	40.5/33/26	40.5/34/26	42/36/27	43/37/27	
Fan motor	Type	Low noise 3-speed fan motor					
	Quantity	1	1	1	1	1	
Fan	Type	Centrifugal, forward-curved Blades					
	Quantity	1	1	2	2	2	
Coil	Row	3	3	3	3	3	
	MAX. working pressure	MPa	1.6	1.6	1.6	1.6	
	Diameter	mm	7	7	7	7	
Dimensions(WxHxD)	CB	mm	632x243x482	773x243x482	908x243x482	908x243x482	1003x243x482
Packing size(WxHxD)	CB	mm	698x270x520	843x270x520	978x270x520	978x270x520	1073x270x520
Net weight	CB	kg	12.3	14.7	17.6	17.6	18.8
Gross weight	CB	kg	14.4	16.9	20.2	20.2	21.5
Water inlet/outlet pipe	inch	RC3/4	RC3/4	RC3/4	RC3/4	RC3/4	
Drain pipe	inch	R3/4	R3/4	R3/4	R3/4	R3/4	

Model name		MKT3-700G30-CL	MKT3-800G30-CL	MKT3-1000G30-CL	MKT3-1200G30-CL	MKT3-1400G30-CL	
Power supply	V/Ph/Hz	220-240/1/50					
Air flow (H/M/L)	m³/h	1190/896/598	1360/1031/687	1700/1284/856	2040/1544/1029	2380/1785/1190	
	CFM	700/528/352	800/607/404	1000/756/504	1200/909/606	1400/1051/700	
Standard external static pressure	Pa	30	30	30	30	30	
Cooling	Capacity (H/M/L)	kW	7.20/6.13/4.79	8.03/6.87/5.40	9.27/8.08/6.35	11.20/9.75/7.67	13.00/11.30/8.90
	Water flow rate (H/M/L)	m³/h	1.24/1.05/0.82	1.38/1.18/0.93	1.59/1.39/1.09	1.93/1.68/1.32	2.24/1.94/1.53
	Water pressure (H/M/L)	kPa	30/23/20	40/31/25	40/31/23	40/32/24	50/39/31
Heating	Capacity (H/M/L)	kW	12.00/9.66/7.01	13.60/10.98/8.02	16.00/13.16/9.61	19.20/15.78/11.53	22.16/18.23/13.37
	Water flow rate (H/M/L)	m³/h	2.04/1.64/1.19	2.31/1.87/1.36	2.72/2.24/1.63	3.26/2.68/1.96	3.77/3.10/2.27
	Water pressure (H/M/L)	kPa	24/19/16	32/25/20	32/25/19	32/26/20	40/32/25
Power input (H/M/L)	W	121/88/72	135/100/80	169/149/133	206/157/126	245/179/145	
Auxiliary electric heater(AEH)	W	1500	2000	2000	2500	2500	
Current input (H/M/L)	A	0.55/0.40/0.33	0.61/0.45/0.36	0.77/0.68/0.60	0.94/0.71/0.57	1.11/0.81/0.66	
Sound pressure level (H/M/L)	dB(A)	46/39/31	44.5/40/33	47/42/35	48/42/35	49.5/43/36	
Fan motor	Type	Low noise 3-speed fan motor					
	Quantity	1	1	1	2	2	
Fan	Type	Centrifugal, forward-curved Blades					
	Quantity	2	3	3	4	4	
Coil	Row	3	3	3	3	3	
	MAX. working pressure	MPa	1.6	1.6	1.6	1.6	
	Diameter	mm	7	7	7	7	
Dimensions(WxHxD)	CB	mm	1178x243x482	1368x243x482	1368x243x482	1658x243x482	1898x243x482
Packing size(WxHxD)	CB	mm	1248x270x520	1438x270x520	1438x270x520	1728x270x520	1968x270x520
Net weight	CB	kg	21.4	25.5	26	33.8	37.0
Gross weight	CB	kg	24.5	29.1	29.7	39.5	41.5
Water inlet/outlet pipe	inch	RC3/4	RC3/4	RC3/4	RC3/4	RC3/4	
Drain pipe	inch	R3/4	R3/4	R3/4	R3/4	R3/4	

Notes:

1. H: High fan speed; M: Medium fan speed; L: Low fan speed;
2. Cooling conditions (H speed): water inlet 7°C, water outlet 12°C, entering air temperature 27°C DB/19.5°C WB, rated external static pressure;
3. Heating conditions (H speed): water inlet 60°C, entering air temperature 21°C DB/15°C, rated external static pressure. Water flow: same with cooling condition;
4. The above sound level is tested in the semi-anechoic room in accordance with GB/T19232 standard when the unit is without accessories and running in dry condition. The background noise is 17.5dB (A);
5. Air flow is tested when the unit is under rated external static pressure without return air box and filter screen in dry condition and 20°C DB;
6. "CC" means that the parameter is tested without air return box; "CB" means that the parameter is tested with air return box;
7. 30Pa is standard, 12Pa and 50Pa need to be customized;
8. Left and right unit can be changed in the field, but cooling and heating capacity should be multiplied with correction factor 0.9;
9. The performance data on above sheet was tested under 220V~50Hz;

3-Row Duct

Model name		MKT3-200G50-CL	MKT3-300G50-CL	MKT3-400G50-CL	MKT3-500G50-CL	MKT3-600G50-CL	
Power supply	V/Ph/Hz	220-240/1/50					
Air flow (H/M/L)	m³/h	340/257/172	510/385/257	680/516/344	850/643/429	1020/799/533	
	CFM	200/151/101	300/226/151	400/303/202	500/379/252	600/470/313	
Standard external static pressure	Pa	50	50	50	50	50	
Cooling	Capacity (H/M/L)	kW	2.50/2.10/1.56	3.40/2.90/2.20	4.41/3.77/2.90	5.00/4.27/3.36	6.00/5.19/4.08
	Water flow rate (H/M/L)	m³/h	0.43/0.36/0.27	0.58/0.50/0.38	0.76/0.65/0.50	0.86/0.73/0.58	1.03/0.89/0.70
	Water pressure (H/M/L)	kPa	27/24/19	24/19/14	24/21/16	30/23/18	38/28/25
Heating	Capacity (H/M/L)	kW	4.10/3.20/2.20	5.67/4.52/3.17	7.35/5.89/4.19	8.60/6.93/5.03	9.98/8.19/6.01
	Water flow rate (H/M/L)	m³/h	0.70/0.54/0.37	0.96/0.77/0.54	1.25/1.00/0.71	1.46/1.18/0.86	1.70/1.38/1.01
	Water pressure (H/M/L)	kPa	22/20/16	20/16/12	20/17/13	24/19/15	31/23/20
Power input (H/M/L)	W	48/38/31	64/50/38	81/64/57	97/65/55	114/85/76	
Auxiliary electric heater(AEH)	W	500	600	1000	1000	1500	
Current input (H/M/L)	A	0.22/0.17/0.14	0.29/0.23/0.17	0.37/0.29/0.26	0.44/0.30/0.25	0.52/0.39/0.35	
Sound pressure level (H/M/L)	dB(A)	40/32/24	42/34/31	44/37/33	46/40/33	47/42/33	
Fan motor	Type	Low noise 3-speed fan motor					
	Quantity	1	1	1	1	1	
Fan	Type	Centrifugal, forward-curved Blades					
	Quantity	1	1	2	2	2	
Coil	Row	3	3	3	3	3	
	MAX. working pressure	MPa	1.6	1.6	1.6	1.6	
	Diameter	mm	7	7	7	7	
Dimensions(WxHxD)	CB	mm	632x243x482	773x243x482	908x243x482	908x243x482	1003x243x482
Packing size(WxHxD)	CB	mm	698x270x520	843x270x520	978x270x520	978x270x520	1073x270x520
Net weight	CB	kg	12.3	14.7	17.6	17.6	18.8
Gross weight	CB	kg	14.4	16.9	20.2	20.2	21.5
Water inlet/outlet pipe	inch	RC3/4	RC3/4	RC3/4	RC3/4	RC3/4	
Drain pipe	inch	R3/4	R3/4	R3/4	R3/4	R3/4	

Model name		MKT3-700G50-CL	MKT3-800G50-CL	MKT3-1000G50-CL	MKT3-1200G50-CL	MKT3-1400G50-CL	
Power supply	V/Ph/Hz	220-240/1/50					
Air flow (H/M/L)	m³/h	1190/896/598	1360/1031/687	1700/1284/856	2040/1544/1029	2380/1791/1194	
	CFM	700/528/352	800/607/404	1000/756/504	1200/909/606	1400/1054/703	
Standard external static pressure	Pa	50	50	50	50	50	
Cooling	Capacity (H/M/L)	kW	7.20/6.13/4.79	8.03/6.87/5.40	9.27/8.08/6.35	11.20/9.75/7.67	13.00/11.30/8.91
	Water flow rate (H/M/L)	m³/h	1.24/1.05/0.82	1.38/1.18/0.93	1.59/1.39/1.09	1.93/1.68/1.32	2.24/1.94/1.53
	Water pressure (H/M/L)	kPa	30/23/20	40/31/25	40/31/23	40/32/24	50/39/31
Heating	Capacity (H/M/L)	kW	12.00/9.66/7.01	13.60/10.98/8.02	16.00/13.16/9.61	19.20/15.78/11.53	22.16/18.25/13.39
	Water flow rate (H/M/L)	m³/h	2.04/1.64/1.19	2.31/1.87/1.36	2.72/2.24/1.63	3.26/2.68/1.96	3.77/3.10/2.27
	Water pressure (H/M/L)	kPa	24/19/16	32/25/20	32/25/19	32/26/20	40/32/25
Power input (H/M/L)	W	131/110/80	169/122/83	204/141/125	243/173/128	291/259/221	
Auxiliary electric heater(AEH)	W	1500	2000	2000	2500	2500	
Current input (H/M/L)	A	0.60/0.50/0.36	0.77/0.55/0.38	0.93/0.64/0.57	1.10/0.79/0.58	1.32/1.18/1.00	
Sound pressure level (H/M/L)	dB(A)	48/43/37	50/39/36	51/45/40	52/46/40	53/49/42.5	
Fan motor	Type	Low noise 3-speed fan motor					
	Quantity	1	1	1	2	2	
Fan	Type	Centrifugal, forward-curved Blades					
	Quantity	2	3	3	4	4	
Coil	Row	3	3	3	3	3	
	MAX. working pressure	MPa	1.6	1.6	1.6	1.6	
	Diameter	mm	7	7	7	7	
Dimensions(WxHxD)	CB	mm	1178x243x482	1368x243x482	1368x243x482	1658x243x482	1898x243x482
Packing size(WxHxD)	CB	mm	1248x270x520	1438x270x520	1438x270x520	1728x270x520	1968x270x520
Net weight	CB	kg	21.4	25.5	26	33.8	35.3
Gross weight	CB	kg	24.5	29.1	29.7	39.5	39.8
Water inlet/outlet pipe	inch	RC3/4	RC3/4	RC3/4	RC3/4	RC3/4	
Drain pipe	inch	R3/4	R3/4	R3/4	R3/4	R3/4	

Notes:

1. H: High fan speed; M: Medium fan speed; L: Low fan speed;
2. Cooling conditions (H speed): water inlet 7°C, water outlet 12°C, entering air temperature 27°C DB/19.5°C WB, rated external static pressure;
3. Heating conditions (H speed): water inlet 60°C, entering air temperature 21°C DB/15°C, rated external static pressure. Water flow: same with cooling condition;
4. The above sound level is tested in the semi-anechoic room in accordance with GB/T19232 standard when the unit is without accessories and running in dry condition. The background noise is 17.5dB (A);
5. Air flow is tested when the unit is under rated external static pressure without return air box and filter screen in dry condition and 20°C DB;
6. "CC" means that the parameter is tested without air return box; "CB" means that the parameter is tested with air return box;
7. 30Pa is standard, 12Pa and 50Pa need to be customized;
8. Left and right unit can be changed in the field, but cooling and heating capacity should be multiplied with correction factor 0.9;
9. The performance data on above sheet was tested under 220V~50Hz;

4-Row Duct

Model		MKT4-200G30	MKT4-300G30	MKT4-400G30	MKT4-500G30	MKT4-600G30	MKT4-800G30	
Power supply		V/Ph/Hz 220-240/1/50						
Air flow (H/M/L)		m³/h	340/255/170	510/385/255	680/510/340	850/640/425	1020/765/510	1360/1020/680
		CFM	200/150/100	300/225/150	400/300/200	500/375/250	600/450/300	800/600/400
Standard external static pressure		Pa	30	30	30	30	30	
Cooling	Capacity (H/M/L)	kW	2.5/2.16/1.87	3.3/2.85/2.47	4.4/3.72/3.22	4.8/4.18/3.64	6.2/5.38/4.65	8.8/7.43/6.57
	Water flow rate	m³/h	0.43/0.37/0.32	0.56/0.50/0.42	0.75/0.64/0.50	0.80/0.71/0.62	1.06/0.92/0.80	1.50/1.28/1.10
	Water pressure drop	kPa	5.0/3.5/3.0	10.0/5.4/3.0	15.0/9.5/8.0	20.0/16.0/15.0	30.0/22.0/16.0	15.0/7.5/5.0
Heating	Capacity (H/M/L)	kW	4.1/3.51/3.03	5.8/5.05/4.35	7.1/6.11/5.33	8.5/7.04/6.28	10.5/9.03/7.77	14.5/12.38/10.88
	Water flow rate	m³/h	0.69/0.59/0.51	0.98/0.85/0.73	1.20/1.00/0.90	1.40/1.20/1.00	1.80/1.50/1.30	2.40/2.00/1.80
	Water pressure drop	kPa	5.0/3.5/3.0	10.0/5.5/3.5	15.0/9.5/8.0	18.0/13.0/10.0	22.6/20.0/15.0	20.0/10.0/6.0
Power input (H/M/L)		W	50/40/35	65/52/46	80/64/56	98/78/69	110/88/77	155/124/109
Auxiliary electric heater (AEH)		W	500	600	1000	1000	1500	2000
Sound pressure level		dB(A)	37/33/27	38/34/28	38/35/29	40/35/30	41/36/31	42/37/32
Fan motor	Type	Low noise 3-speed fan motor						
	Quantity	1	1	1	1	1	2	
Fan	Type	Centrifugal, forward-curved Blades						
	Quantity	1	2	2	2	2	4	
Coil	Row	4	4	4	4	4	4	
	Max. working pressure	MPa	1.6	1.6	1.6	1.6	1.6	
	Diameter	mm	Ø9.52	Ø9.52	Ø9.52	Ø9.52	Ø9.52	
Net dimensions (WxHxD)		mm	741x241x522	841x241x522	941x241x522	941x241x522	1161x241x522	1461x241x522
Packing size (WxHxD)		mm	790x260x550	890x260x550	990x260x550	990x260x550	1210x260x550	1510x260x550
Net weight		kg	15.3	17.5	20.7	20.7	23.5	32.9
Gross weight		kg	17.6	20	23.1	23.1	26.5	36.5
Water inlet/outlet pipe		inch	RC3/4	RC3/4	RC3/4	RC3/4	RC3/4	RC3/4
Drain pipe		inch	ZG3/4	ZG3/4	ZG3/4	ZG3/4	ZG3/4	ZG3/4

Model		MKT4-1000G30	MKT4-1200G30	MKT4-1400G30	
Power supply		V/Ph/Hz 220-240/1/50			
Air flow (H/M/L)		m³/h	1700/1275/850	2040/1530/1020	2380/1785/1190
		CFM	1000/750/500	1200/900/600	1400/1050/700
Standard external static pressure		Pa	30	30	30
Cooling	Capacity (H/M/L)	kW	9.5/8.18/7.06	11.8/9.82/8.74	13/11.23/9.83
	Water flow rate	m³/h	1.60/1.40/1.20	2.00/1.70/1.50	2.20/1.90/1.70
	Water pressure drop	kPa	18.3/12.1/8.0	33.0/24.8/11.4	35.0/23.9/15.0
Heating	Capacity (H/M/L)	kW	16.3/13.45/12.05	16.5/14.05/12.23	17/14.31/12.69
	Water flow rate	m³/h	2.70/2.30/2.00	2.80/2.40/2.10	2.90/2.50/2.30
	Water pressure drop	kPa	20.6/13.9/8.3	36.1/20.9/13.2	37.0/26.0/17.0
Power input (H/M/L)		W	180/144/126	220/176/154	275/220/193
Auxiliary electric heater (AEH)		W	2000	3000	3000
Sound pressure level		dB(A)	44/39/33	45/40/34	47/42/36
Fan motor	Type	Low noise 3-speed fan motor			
	Quantity	2	2	2	
Fan	Type	Centrifugal, forward-curved Blades			
	Quantity	4	4	4	
Coil	Row	4	4	4	
	Max. working pressure	MPa	1.6	1.6	1.6
	Diameter	mm	Ø9.52	Ø9.52	Ø9.52
Net dimensions (WxHxD)		mm	1566x241x522	1856x241x522	2022x241x522
Packing size (WxHxD)		mm	1615x260x550	1905x260x550	2070x260x550
Net weight		kg	35.4	40.5	44.1
Gross weight		kg	39.1	44	49.4
Water inlet/outlet pipe		inch	RC3/4	RC3/4	RC3/4
Drain pipe		inch	ZG3/4	ZG3/4	ZG3/4

Notes:

1. H: High fan speed; M: Medium fan speed; L: Low fan speed.
2. The data is the performance in relevant standard external static pressure.
3. Cooling conditions: Entering water 7°C, leaving water 12°C, Entering air temperature 27°C DB/19°C WB.
Heating conditions: Entering water 50°C, the same water flow as the cooling conditions, Entering air temperature 20°C DB.
4. Noise is tested in a semi-anechoic test room.
5. Auxiliary electric heater (AEH) is optional.

A4 Type Duct

Model		MKT4-800G50-A4	MKT4-1000G50-A4	MKT4-1200G50-A4	
Power supply		V/Ph/Hz 220-240/1/50			
Air flow (H/M/L)		m³/h	1400/1342/1200	1650/1527/1405	2040/1851/1666
		CFM	856/790/706	970/900/827	1206/1090/981
Standard external static pressure		Pa	50	50	50
Cooling	Capacity (H/M/L)	kW	7.92/7.56/7.09	8.15/7.93/7.54	10.8/10.17/9.55
	Water flow rate	m³/h	1.36/1.30/1.22	1.40/1.36/1.29	1.80/1.70/1.60
	Water pressure drop	kPa	79.5/73.7/67.5	42.1/39.2/36.4	62.0/52.6/47.6
Heating	Capacity (H/M/L)	kW	10.42/9.89/9.12	11.25/10.72/10.06	14.3/13.23/12.22
	Water flow rate	m³/h	1.70/1.60/1.50	1.90/1.80/1.70	2.40/2.20/2.00
	Water pressure drop	kPa	79.1/76.9/69.2	46.1/44.6/41.5	52.0/47.8/41.8
Power input (H/M/L)		W	144/124/105	176/146/128	320/284/250
Sound pressure level		dB(A)	48.4/47.9/46.6	49.5/48.1/47.3	50.9/50/48.5
Fan motor	Type	Low noise 3-speed fan motor			
	Quantity	1	1	1	
Fan	Type	Centrifugal, forward-curved Blades			
	Quantity	2	2	2	
Coil	Row	4	4	4	
	Max. working pressure	MPa	1.6	1.6	1.6
	Diameter	mm	Ø9.52	Ø9.52	Ø9.52
Net dimensions (WxHxD)		mm	1180x342x612	1180x342x612	1369x342x612
Packing size (WxHxD)		mm	1310x380x693	1310x380x693	1490x380x693
Net weight		kg	39.3	40.8	46.3
Gross weight		kg	47	49.6	56.4
Water inlet/outlet pipe		inch	RC3/4	RC3/4	RC3/4
Drain pipe		inch	R3/4	R3/4	R3/4

Model		MKT4-1400G50-A4	MKT4-1600G50-A4	MKT4-1800G50-A4	MKT4-2000G50-A4	
Power supply		V/Ph/Hz 220-240/1/50				
Air flow (H/M/L)		m³/h	2420/1851/1666	2430/1917/1742	3380/2239/1878	3670/2544/2199
		CFM	1427/1090/981	1431/1128/1025	1990/1318/1105	2160/1497/1294
Standard external static pressure		Pa	50	50	50	50
Cooling	Capacity (H/M/L)	kW	12.14/10.17/9.55	12.19/10.54/9.87	16.16/12.35/11.01	17.34/13.75/12.44
	Water flow rate	m³/h	2.00/1.70/1.60	2.10/1.80/1.70	2.70/2.20/1.90	2.90/2.40/2.10
	Water pressure drop	kPa	65.5/52.6/47.6	70.9/54.1/49.1	239.6/150.4/117.8	283.3/119.2/159.7
Heating	Capacity (H/M/L)	kW	16.08/13.23/12.22	16.55/13.83/12.9	21.7/15.79/13.91	23.4/17.92/16.08
	Water flow rate	m³/h	2.70/2.20/2.00	2.72/2.30/2.10	3.50/2.70/2.40	3.90/3.00/2.70
	Water pressure drop	kPa	57.6/49.8/42.1	65.5/49.8/43.7	241.9/146.1/115.5	283.0/193.9/151.5
Power input (H/M/L)		W	392/284/250	482/338/296	538/358/308	583/387/334
Sound pressure level		dB(A)	51.7/50/49.5	52.9/50.7/50	53.6/51.1/50.2	54.4/52.7/51.6
Fan motor	Type	Low noise 3-speed fan motor				
	Quantity	1	1	1	1	
Fan	Type	Centrifugal, forward-curved Blades				
	Quantity	2	2	3	3	
Coil	Row	4	4	4	4	
	Max. working pressure	MPa	1.6	1.6	1.6	1.6
	Diameter	mm	Ø9.52	Ø9.52	Ø9.52	Ø9.52
Net dimensions (WxHxD)		mm	1369x342x612	1369x342x612	1500x342x612	1500x342x612
Packing size (WxHxD)		mm	1490x380x693	1490x380x693	1620x380x693	1620x380x693
Net weight		kg	46.3	46.3	54.8	54.8
Gross weight		kg	56.4	56.4	64.6	64.6
Water inlet/outlet pipe		inch	RC3/4	RC3/4	RC3/4	RC3/4
Drain pipe		inch	R3/4	R3/4	R3/4	R3/4

Notes:

1. H: High fan speed; M: Medium fan speed; L: Low fan speed.
2. The data is the performance in relevant standard external static pressure.
3. Cooling conditions: Entering water 7°C, leaving water 12°C, Entering air temperature 27°C DB/19°C WB.
Heating conditions: Entering water 50°C, the same water flow as the cooling conditions, Entering air temperature 20°C DB.
4. Noise is tested in a semi-anechoic test room.

District Cooling Duct

Model			MKS3-200G30-CL	MKS3-300G30-CL	MKS3-400G30-CL	MKS3-500G30-CL	MKS3-600G30-CL	
Power supply			V/Ph/Hz					220-240/1/50
Air flow (H/M/L)	0Pa (H/M/L)	m³/h	458/360/286	607/492/357	905/648/469	1044/736/457	1244/951/583	
		CFM	269/212/168	357/289/210	532/381/276	614/433/269	732/559/343	
	30Pa (H/M/L)	m³/h	389/293/-	546/434/317	771/514/333	923/650/397	1111/830/467	
		CFM	229/172/-	321/255/187	454/302/196	543/382/234	654/488/275	
	60Pa (H/M/L)	m³/h	318/-/-	454/-/-	623/373/248	736/466/252	964/669/342	
		CFM	187/-/-	267/-/-	366/219/145.9	433/274/148.2	567/394/201	
Cooling	Capacity	0Pa (H/M/L)	2.06/1.76/1.46	2.91/2.54/2.01	3.67/3.05/2.40	4.55/3.70/2.64	5.36/4.56/3.25	
		30Pa (H/M/L)	1.87/1.54/-	2.68/2.33/1.62	3.26/2.59/1.79	4.12/3.39/2.04	5.04/4.18/2.82	
		60Pa (H/M/L)	1.64/-/-	2.41/-/-	2.79/1.94/1.49	3.62/2.68/1.84	4.48/3.52/2.11	
	Water pressure drop	0Pa (H/M/L)	22.3/16.3/9.9	39.1/31.0/19.4	29.1/22.5/15.5	33.2/23.1/13.8	51.5/37.8/21.1	
		30Pa (H/M/L)	19.2/13.0/-	35.3/28.0/16.8	25.6/18.0/9.7	27.7/20.0/12	45.8/33.0/16.6	
		60Pa (H/M/L)	15.3/-/-	29.6/-/-	20.8/11.8/7.1	22.2/13.2/7.9	37.4/25.4/10.2	
	Water flow rate	0Pa (H/M/L)	0.20/0.17/0.11	0.28/0.24/0.19	0.36/0.30/0.23	0.44/0.33/0.25	0.52/0.44/0.31	
		30Pa (H/M/L)	0.19/0.15/-	0.27/0.23/0.14	0.32/0.30/0.17	0.40/0.33/0.20	0.49/0.41/0.27	
		60Pa (H/M/L)	0.17/-/-	0.24/-/-	0.28/0.20/0.13	0.36/0.27/0.16	0.44/0.35/0.21	
	Power input	0Pa (H/M/L)	W	55.0/42.0/30	71.0/57.0/48.0	96.0/78.0/68.0	121.6/93.6/76.4	141.0/115.2/93.6
		30Pa (H/M/L)	W	51.4/39.0/-	63.0/50.0/43	91.0/73.0/63.0	114.1/85.0/77.5	133.8/107.0/85.4
		60Pa (H/M/L)	W	52.0/-/-	65.0/-/-	85.0/67.0/60	107.6/79.6/68	124.5/96.7/75.1
Auxiliary electric heater (AEH)	W	500	600	1000	1000	1500		
Sound pressure level	dB(A)	40.0/36.0/28.0	44.0/38.0/33.0	44.0/39.0/35.0	47.0/42.0/34.0	47.0/42.5/34.0		
Fan motor	Type	/	AC motor					
	Quantity	/	1	1	1	1	1	
Fan	Type	/	Centrifugal, forward-curved blades					
	Quantity	/	1	1	2	2	2	
Coil	Row	/	3					
	Max. working pressure	MPa	1.6MPa					
	Diameter	mm	7					
Net dimensions (WxHxD)	mm	632x243x514	773x243x514	908x243x514	908x243x514	1003x243x514		
Packing size (WxHxD)	mm	698x270x540	843x270x540	978x270x540	978x270x540	1073x270x540		
Net weight	kg	13	15.7	18.9	19.1	20.3		
Gross weight	kg	14.7	18.1	21	21.2	22.5		
Water inlet/outlet pipe	inch	RC3/4						
Drain pipe	inch	ZG3/4						

Model			MKS3-700G30-CL	MKS3-800G30-CL	MKS3-1000G30-CL	MKS3-1200G30-CL	MKS3-1400G30-CL	
Power supply			V/Ph/Hz					220-240V/1/50
Air flow (H/M/L)	0Pa (H/M/L)	m³/h	1381/1016/722	1665/1293/808	1762/1571/933	2361/1655/1020	2725/2103/1432	
		CFM	812/598/425	979/761/475	1036/924/549	1389/974/600	1603/1237/842	
	30Pa (H/M/L)	m³/h	1290/961/680	1459/1120/659	1567/1402/832	2114/1500/877	2477/2000/1349	
		CFM	759/565/400	858/659/388	922/825/489	1244/882/516	1457/1176/794	
	60Pa (H/M/L)	m³/h	1131/842/564	1199/901/510	1315/1165/680	1795/1248/738	2171/1777/1175	
		CFM	665/495/332	705/530/300	774/685/400	1056/734/434	1277/1045/691	
Cooling	Capacity	0Pa (H/M/L)	5.74/4.76/3.81	7.14/6.05/4.26	7.29/6.59/4.38	9.12/7.40/5.16	10.44/8.96/6.90	
		30Pa (H/M/L)	5.42/4.53/3.60	6.49/5.53/3.25	6.73/5.95/3.99	8.50/6.87/4.37	9.79/8.58/6.65	
		60Pa (H/M/L)	4.99/4.09/3.11	5.66/4.59/2.37	5.47/4.91/3.25	7.55/5.92/2.72	8.89/7.81/5.86	
	Water pressure drop	0Pa (H/M/L)	72.8/51.1/34.3	25.4/19.7/10.6	31.1/28.1/16.7	34.4/22.6/12.5	32.9/25.5/17.4	
		30Pa (H/M/L)	63.3/45.9/30.8	22.0/17.0/6.4	27.1/24.3/14.6	30.6/20.0/9.4	29.9/24.0/16.8	
		60Pa (H/M/L)	55.5/38.8/24.4	17.7/12.5/4.0	17.8/15.8/12.6	24.8/16.1/4.4	25.8/20.8/14.2	
	Water flow rate	0Pa (H/M/L)	0.56/0.46/0.37	0.70/0.59/0.41	0.71/0.65/0.44	0.89/0.71/0.49	1.01/0.87/0.67	
		30Pa (H/M/L)	0.53/0.44/0.35	0.64/0.54/0.32	0.66/0.61/0.49	0.83/0.67/0.42	0.95/0.84/0.65	
		60Pa (H/M/L)	0.49/0.40/0.31	0.56/0.46/0.46	0.53/0.50/0.33	0.74/0.58/0.27	0.87/0.77/0.58	
	Power input	0Pa (H/M/L)	W	162.5/141.2/121.9	177.0/162.5/131.4	214.2/199.1/140.8	272.2/220.7/186.0	303.0/293.0/263.0
		30Pa (H/M/L)	W	151.3/131.0/112.7	163.5/148.0/120.1	201.1/185.0/129.5	256.4/206.0/172.4	270.6/259.0/237.7
		60Pa (H/M/L)	W	138.1/118.8/99.5	148.0/131.4/105.6	185.0/166.9/142.8	239.6/183.9/153.4	255.0/240.0/217.0
Auxiliary electric heater (AEH)	W	1500	2000	2000	2500	2500		
Sound pressure level	dB(A)	48.0/45.0/37.0	47.0/44.0/35.0	50.0/48.0/44.0	50.0/45.0/38.0	50.0/47.0/40		
Fan motor	Type	/	AC motor					
	Quantity	/	1	1	1	2	2	
Fan	Type	/	Centrifugal, forward-curved blades					
	Quantity	/	2	3	3	4	4	
Coil	Row	/	3					
	Max. working pressure	MPa	1.6MPa					
	Diameter	mm	7					
Net dimensions (WxHxD)	mm	1178x243x514	1368x243x514	1368x243x514	1658x243x514	1898x243x514		
Packing size (WxHxD)	mm	1248x270x540	1438x270x540	1438x270x540	1728x270x540	1968x270x540		
Net weight	kg	22.6	27.2	27.2	35.1	39.4		
Gross weight	kg	25.3	30.1	30.2	39.7	44.4		
Water inlet/outlet pipe	inch	RC3/4						
Drain pipe	inch	ZG3/4						

Notes:

1. H: High fan speed; M: Medium fan speed; L: Low fan speed;
2. Cooling conditions: water inlet 5.5°C, water outlet 14.5°C, entering air temperature 24°C DB/18°C WB, with air return plenum and without filter;
3. Sound pressure level is tested in the semi-anechoic room with background noise is 17.5dB (A), when the unit is without accessories and running in dry condition, at 1m below the vertical center line of the unit with 2m inlet & outlet duct;
4. Air flow is tested under dry condition, 20 °C DB, with air return plenum and without filter;
5. Normal data is tested under 30Pa;
6. Left and right unit can be changed in the field, but cooling should be multiplied with correction factor 0.9;
7. The performance data on above sheet was tested under 220V~50Hz;
8. Auxiliary electric heater (AEH) is optional;
9. All specifications are subject to change by the manufacturer without prior notice.

4-Pipe Duct

Model			MKT3-200FG30	MKT3-300FG30	MKT3-400FG30	MKT3-500FG30	MKT3-600FG30	
Power supply			V/Ph/Hz					220-240/1/50
Air flow (H/M/L)	m³/h		340/255/170	510/385/255	680/510/340	850/640/425	1020/765/510	
	CFM		200/150/100	300/225/150	400/300/200	500/375/250	600/450/300	
Standard external static pressure			Pa					G12 models: 12; G30 models: 30
Cooling	Capacity (H/M/L)	kW	2/1.76/1.52	2.7/2.35/2.13	3.6/3.15/2.76	4.3/3.74/3.32	5/4.32/3.84	
	Water flow rate	m³/h	0.35/0.30/2.60	0.46/0.40/0.38	0.60/0.54/0.48	0.75/0.64/0.57	0.86/0.74/0.66	
	Water pressure drop	kPa	11.0/9.0/6.5	23.0/17.3/12.7	58.7/55.2/51.0	142.2/113.4/79	24.7/19.9/14.8	
Heating	Capacity (H/M/L)	kW	3/2.64/2.22	4/3.48/3	5.2/4.47/3.9	5.7/5.02/4.33	7.2/6.19/5.33	
	Water flow rate	m³/h	0.26/0.23/0.20	0.34/0.30/0.27	0.45/0.40/0.35	0.49/0.44/0.39	0.64/0.53/0.48	
	Water pressure drop	kPa	8.5/7.2/5.8	13.8/11.3/9.0	18.4/16.2/12.3	31.0/22.7/17.8	50.0/42.2/33.0	
Power input	12Pa (H/M/L)	W	33/26/23	53/38/31	66/48/42	87/54/44	100/67/56	
	30Pa (H/M/L)	W	49/39/34	64/50/42	75/55/48	96/58/48	114/76/64	
Sound pressure level	12Pa (H/M/L)	dB(A)	35/32/26	36/33/27	37/34/28	40/36/30	42/38/32	
	30Pa (H/M/L)	dB(A)	41/37/31	42/38/32	43/39/33	44/40/34	45/41/35	
Fan motor	Type	Low noise 3-speed fan motor						
	Quantity	1	1	1	1	1		
Fan	Type	Centrifugal, forward-curved Blades						
	Quantity	1	2	2	2	2		
Coil	Row	3	3	3	3	3		
	Max. working pressure	MPa	1.6	1.6	1.6	1.6		
	Diameter	mm	Ø9.52	Ø9.52	Ø9.52	Ø9.52		
Net dimensions (WxHxD)	mm	741x241x522	841x241x522	941x241x522	941x241x522	1161x241x522		
Packing size (WxHxD)	mm	790x260x555	890x260x555	990x260x555	990x260x555	1210x260x555		
Net weight	kg	15.1	17.5	20.7	20.7	23.5		
Gross weight	kg	17.4	20	23.1	23.1	26.5		
Water inlet/outlet pipe	inch	RC3/4	RC3/4	RC3/4	RC3/4	RC3/4		
Drain pipe	inch	R3/4	R3/4	R3/4	R3/4	R3/4		

Model			MKT3-800FG30	MKT3-1000FG30	MKT3-1200FG30	MKT3-1400FG30		
Power supply			V/Ph/Hz					220-240/1/50
Air flow (H/M/L)	m³/h		1360/1020/680	1700/1275/850	2040/1530/1020	2380/1785/1190		
	CFM		800/600/400	1000/750/500	1200/900/600	1400/1050/700		
Standard external static pressure			Pa					G12 models: 12; G30 models: 30
Cooling	Capacity (H/M/L)	kW	6.8/5.78/5.11	7.8/6.74/5.88	10.2/8.89/7.85	11.5/9.9/8.86		
	Water flow rate	m³/h	1.17/1.00/0.88	1.35/1.15/1.00	1.75/1.51/1.35	1.90/1.70/1.50		
	Water pressure drop	kPa	26.3/20.6/15.5	32.0/24.3/18.1	41.3/34.9/24.7	74.8/58.3/39		
Heating	Capacity (H/M/L)	kW	9.6/8.45/7.2	10.8/9.61/8.1	13.5/12.15/10.26	15.5/13.48/11.78		
	Water flow rate	m³/h	0.83/0.74/0.65	0.91/0.83/0.73	1.17/1.06/0.93	1.34/1.20/1.07		
	Water pressure drop	kPa	11.0/10.4/8.9	17.3/14.2/11.0	27.6/23.3/16.9	33.6/27.6/20.0		
Power input	12Pa (H/M/L)	W	145/130/111	180/104/88	210/140/123	222/201/182		
	30Pa (H/M/L)	W	154/132/113	193/114/97	230/157/131	278/262/228		
Sound pressure level	12Pa (H/M/L)	dB(A)	43/39/33	45/41/35	46/42/36	48/44/38		
	30Pa (H/M/L)	dB(A)	46/42/36	47/43/37	48/44/38	49/45/39		
Fan motor	Type	Low noise 3-speed fan motor						
	Quantity	2	2	2	2	2		
Fan	Type	Centrifugal, forward-curved Blades						
	Quantity	4	4	4	4	4		
Coil	Row	3	3	3	3			
	Max. working pressure	MPa	1.6	1.6	1.6	1.6		
	Diameter	mm	Ø9.52	Ø9.52	Ø9.52	Ø9.52		
Net dimensions (WxHxD)	mm	1461x241x522	1566x241x522	1856x241x522	2022x241x522			
Packing size (WxHxD)	mm	1510x260x555	1615x260x555	1905x260x555	2070x260x555			
Net weight	kg	32.4	34.9	40	43.6			
Gross weight	kg	36	38.6	43.5	48.9			
Water inlet/outlet pipe	inch	RC3/4	RC3/4	RC3/4	RC3/4			
Drain pipe	inch	R3/4	R3/4	R3/4	R3/4			

Notes:

1. H: High fan speed; M: Medium fan speed; L: Low fan speed.
2. Cooling conditions: Entering water 7°C, leaving water 12°C, Entering air temperature 27°C DB/19°C WB. Heating conditions: Entering water 70°C, leaving water 60°C, Entering air temperature 20°C DB.
3. Noise is tested in a semi-anechoic test room.

High Static Pressure Duct



Model: 800/1000/1200/1400/1600/1800/2200CFM



RM05+FCU KIT
Optional



KJRP-86/MFK-E (Optional)
KJRP-86/MFKS-E (Optional)
KJRP-86A/BMFNKD-E (Optional)

Features

- Large air volume and capacity, high static pressure(Up to 100Pa).
- Easy to clean and change air filter.
- Auxiliary electric heater (AEH) is optional.
- Air return flange and air plenum with filter are standard, air return from the back side.
- 220V wired controller is optional.
- Standard extended drainage pan for protecting ceiling better.
- Four-speed motor with super-high speed reserved.
- Pipe connection from left or right.

High external static pressure with long duct distribution, ideal for large sized spaces.



Flexible Installation

Left and right hand piping connections are optional, flexible installation.

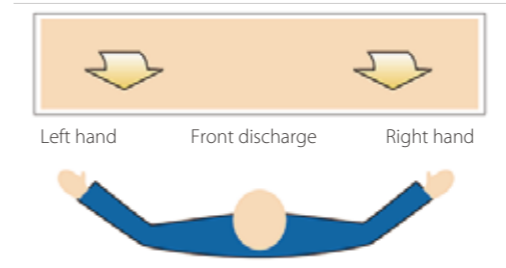

Multiple Fan Speeds

The AC Series comes with 3 fan speed option to meet the needs of different indoor conditions.

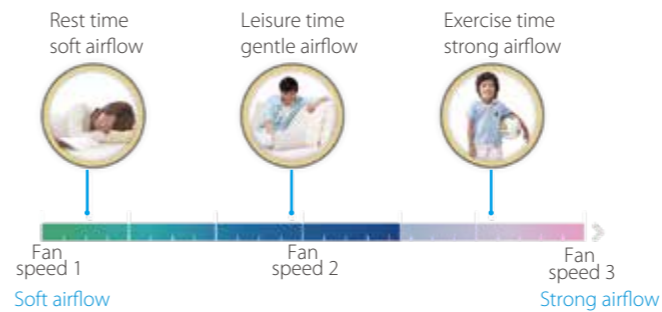

Compact Size

All the units are 400mm high, easy for limited space installation.

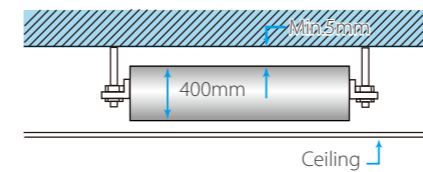

Easy to clean and change air filter

Changing the air filter only needs to loosen a screw at the air supply side to pull out the air filter, easy and effective operation.



Control solutions

The duct series controlled by wired controller, centralized controller or BMS need to be customization FCU KIT.



Flexible Duct Design

High Static Pressure Duct supplies a wide static pressure from 0Pa to 100Pa which can support short to long duct with high ceiling air supply.

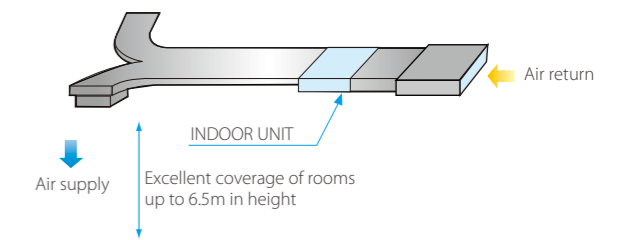

Double-skin Drainage Pan

A double-skin drainage pan provides double protection for ceilings.

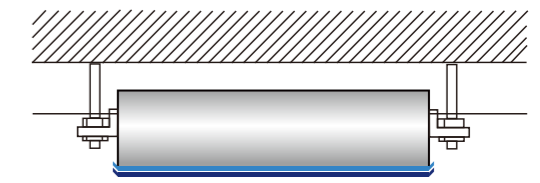

Electric heater is optional

Different models can be customized with different electrical auxiliary heat capacity.



High Static Pressure Duct

Model		MKT3H-800G70 MKT3H-800EG70	MKT3H-1000G70 MKT3H-1000EG70	MKT3H-1200G70 MKT3H-1200EG70	MKT3H-1400G70 MKT3H-1400EG70	
Power supply		V/Ph/Hz	220-240/1/50			
Air flow (H/M/L)	m³/h	1360/1220/1090	1700/1530/1380	2040/1880/1610	2380/2120/1860	
	CFM	800/720/640	1000/900/810	1200/1105/950	1400/1250/1095	
Standard external static pressure		Pa	70	70	70	70
Cooling	Capacity (H/M/L)	kW	6.6/6.37/6.12	8.8/8.19/7.57	10/9.44/8.53	12/11.47/10.24
	Water flow rate	m³/h	1.13/1.09/1.05	1.61/1.59/1.51	1.72/1.62/1.52	2.00/1.97/1.76
	Water pressure drop	kPa	14.5/11.7/13.2	35.2/34.0/30.8	35.3/33.5/31.4	52.1/48.1/44.3
Heating	Capacity (H/M/L)	kW	9.7/8.54/7.18	13.2/11.48/9.9	15/12.9/11.25	17.9/15.75/13.6
	Water flow rate	m³/h	1.48/1.44/1.20	2.20/1.95/1.68	2.55/2.19/1.90	3.00/2.60/2.30
	Water pressure drop	kPa	25.5/24.2/22.8	42.8/40.8/36.5	55.5/52.8/48.1	47.3/45.5/41.9
Power input (H/M/L)		W	320/300/285	350/320/300	350/320/290	350/300/285
Auxiliary electric heater (AEH)		W	5000	5000	5000	5000
Sound pressure level		dB(A)	49/42/35	50/43/36	51/44/37	52/45/38
Fan motor	Type	Low noise 3-speed fan motor				
	Quantity	1	1	1	1	
Fan	Type	Centrifugal, forward-curved Blades				
	Quantity	1	1	1	1	
Coil	Row	2	3	3	4	
	Max. working pressure	MPa	1.6	1.6	1.6	1.6
	Diameter	mm	Φ9.52	Φ9.52	Φ9.52	Φ9.52
Net dimensions(WxHxD)		mm	946x400x816	946x400x816	946x400x816	946x400x816
Packing size (non-AEH/with-AEH)		mm	Left connection: 1075x480x857/1075x480x925			
Net weight (non-AEH/with-AEH)		kg	50/53	52/55	52/55	54/57
Gross weight (non-AEH/with-AEH)		kg	55/58	57/60	57/60	59/62
Water inlet/outlet pipe		inch	RC3/4	RC3/4	RC3/4	RC3/4
Drain pipe		inch	ZG5/4	ZG5/4	ZG5/4	ZG5/4

Notes:

1. H: High fan speed; M: Medium fan speed; L: Low fan speed.
2. The data is the performance in relevant standard external static pressure.
3. Cooling conditions: Entering water 7°C, leaving water 12°C, Entering air temperature 27°C DB/19°C WB.
Heating conditions: Entering water 50°C, the same water flow as the cooling conditions, Entering air temperature 20°C DB.
4. Noise is tested in a semi-anechoic test room.
5. The external static pressure test condition is the same as Eurovent conditions(External static pressure is different for each models.)
6. Auxiliary electric heater (AEH) is optional.

Model		MKT3H-1600G100 MKT3H-1600EG100	MKT3H-1800G100 MKT3H-1800EG100	MKT3H-2200G100 MKT3H-2200EG100	
Power supply		V/Ph/Hz	220-240/1/50		
Air flow (H/M/L)	m³/h	2720/2450/2170	3060/2750/2450	3740/3360/2990	
	CFM	1600/1440/1280	1800/1620/1440	2200/1980/1760	
Standard external static pressure		Pa	100	100	100
Cooling	Capacity (H/M/L)	kW	14.1/13.03/11.87	15.8/14.6/13.46	19.9/18.58/17.24
	Water flow rate	m³/h	2.40/2.24/2.00	2.70/2.50/2.30	3.16/2.90/2.59
	Water pressure drop	kPa	86.0/73.4/60.7	129.0/113.0/100.1	147.9/124.2/98.6
Heating	Capacity (H/M/L)	kW	21.2/18.23/15.69	23.8/20.94/17.85	30.26/27.22.5
	Water flow rate	m³/h	3.60/3.00/2.60	4.00/3.40/3.00	5.00/4.50/3.80
	Water pressure drop	kPa	87.8/75.1/63.0	168.0/147.0/127.2	163.7/130.9/102.0
Power input (H/M/L)		W	550/520/500	800/680/620	950/860/760
Auxiliary electric heater (AEH)		W	9500	9500	9500
Sound pressure level		dB(A)	54/47/40	60/53/46	61/54/47
Fan motor	Type	Low noise 3-speed fan motor			
	Quantity	1	1	1	
Fan	Type	Centrifugal, forward-curved Blades			
	Quantity	2	2	2	
Coil	Row	3	3	3	
	Max. working pressure	MPa	1.6	1.6	1.6
	Diameter	mm	Φ9.52	Φ9.52	Φ9.52
Net dimensions(WxHxD)		mm	1290x400x809	1290x400x809	1290x400x809
Packing size (non-AEH/with-AEH)		mm	Left connection: 1448x460x877/1448x460x950		
Net weight (non-AEH/with-AEH)		kg	76/82	76/82	76/82
Gross weight (non-AEH/with-AEH)		kg	83/89	83/89	83/89
Water inlet/outlet pipe		inch	RC3/4	RC3/4	RC3/4
Drain pipe		inch	ZG5/4	ZG5/4	ZG5/4

Notes:

1. H: High fan speed; M: Medium fan speed; L: Low fan speed.
2. The data is the performance in relevant standard external static pressure.
3. Cooling conditions: Entering water 7°C, leaving water 12°C, Entering air temperature 27°C DB/19°C WB.
Heating conditions: Entering water 50°C, the same water flow as the cooling conditions, Entering air temperature 20°C DB.
4. Noise is tested in a semi-anechoic test room.
5. The external static pressure test condition is the same as Eurovent conditions(External static pressure is different for each models.)
6. Auxiliary electric heater (AEH) is optional.

Wall Mounted Series



Model: 250/300/400/500/600 CFM



R51 Standard



KJR-29B Optional

Features

- Display shut off (for Type A and P panels though Wireless Remote Controllers RM12F/BGF-E).
- Built-in 3-way electromagnetic valve.
- Remote controller as standard, wired controller is optional.
- Easy and low cost installation.
- The panel can be easily removed, simple maintenance and easy to change filter.
- Multi-directional outlet pipe feature: left/right/rear, to meet the needs of different rooms.
- Compatible with 0-10V control function.
- Auxiliary electric heater (AEH) is optional.

Stylish panel, ideal for rooms with no or narrow ceilings.



Digital Display On/Off

Indoor unit displays can be shut off at night, creating a better environment for rest.



Multiple Fan Speeds

The AC Series comes with 3 fan speed option to meet the needs of different indoor conditions.

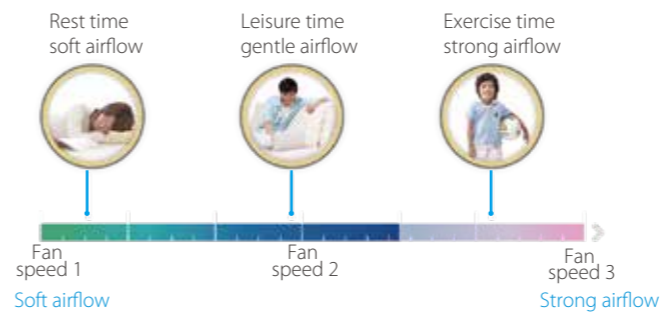

Auto Swing Louver

The Auto Swing Louver function ensures that the air direction corresponds to the mode selected.

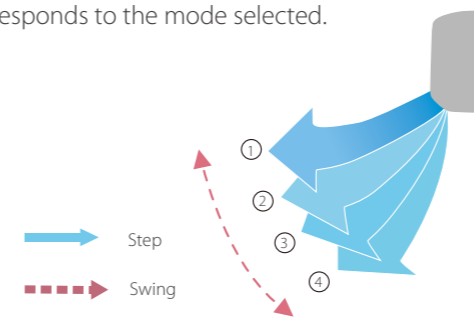

Control solutions

The fan coil units can be connected to Midea central controllers through the customized XYE port, also can be connected to Modbus gateway through the customized PQE port with Modbus RTU protocol.



Variety stylish Panel

Variety stylish panel with three options (A Type, P Type), perfect fusion in all kinds of decoration.

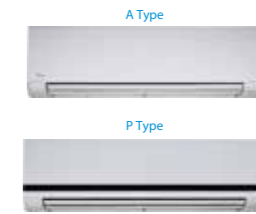

Flexible Pipe Outlet Direction

Multi-outlet pipe method for both refrigerant pipe and drain pipe: left/right/rear, more flexible for installation.

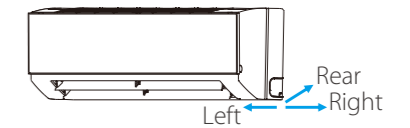

Easy Maintenance

Removable front panel making maintenance convenient.

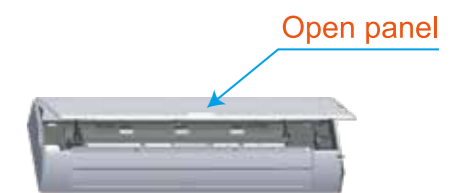

Exposed Installation, No Need Ceilings

The Wall Mounted can be installed against wall, no need ceilings, simplifying installation.



Wall Mounted (A Type)

Model		MKG-250-C	MKG-300-C	MKG-400-C	MKG-500-C	MKG-600-C	
Power supply		V/Ph/Hz 220-240/1/50					
Air flow (H/M/L)		m ³ /h	435/396/342	523/426/351	660/534/480	841/723/594	915/836/714
		CFM	256/233/201	308/251/206	388/314/282	495/425/349	538/492/420
Cooling	Capacity (H/M/L)	kW	1.94/1.84/1.68	2.64/2.4/1.99	2.94/2.58/2.34	4.01/3.61/3.1	4.61/4.33/3.84
	Water flow rate (H/M/L)	m ³ /h	0.35/0.33/0.3	0.47/0.43/0.36	0.53/0.46/0.42	0.72/0.65/0.56	0.83/0.78/0.69
	Water pressure drop (H/M/L)	kPa	31.6/28.6/25.2	37.5/30/24	57.2/47.6/38.7	47.1/33.5/29.7	51/39.5/34
Heating	Capacity (H/M/L)	kW	2.34/2.15/1.94	2.9/2.6/2.22	3.46/2.75/2.52	4.39/3.8/3.27	4.55/4.2/3.82
	Water flow rate (H/M/L)	m ³ /h	0.43/0.39/0.35	0.53/0.47/0.4	0.63/0.5/0.46	0.8/0.69/0.6	0.83/0.76/0.69
	Water pressure drop (H/M/L)	kPa	37.5/34.9/30	40.6/31.5/25	61.9/55.1/46.2	48.6/40.8/31.7	48/43/33
Power input (H/M/L)		W	35/32/31	47/43/39	54/51/47	60/54/48	72/60/55
Auxiliary electric heater (AEH)		W	750	750	750	900	900
Sound pressure level (H/M/L)		dB(A)	30/24/20	35/29/24	37/31/26	39/33/28	40/34/29
Sound power level (H/M/L)		dB(A)	44/42/40	48/43/39	57/51/47	54/50/45	59/55/50
Fan motor	Type	Low noise 3-speed fan motor					
	Quantity	1	1	1	1	1	
Fan	Type	Tangential fan	Tangential fan	Tangential fan	Tangential fan	Tangential fan	
	Quantity	1	1	1	1	1	
Coil	Row	2	2	2	2	2	
	Max. working pressure	MPa	1.6	1.6	1.6	1.6	1.6
	Diameter	mm	Φ7	Φ7	Φ7	Φ7	Φ7
Net dimensions (WxHxD)		mm	915×290×233	915×290×233	915×290×233	1072×315×237	1072×315×237
Packing size (WxHxD)		mm	1020×390×315	1020×390×315	1020×390×315	1180×415×315	1180×415×315
Net weight		kg	13	13	13.3	15.8	15.8
Gross weight		kg	16.3	16.3	16.7	19.4	19.4
Water inlet/outlet pipe		inch	G3/4	G3/4	G3/4	G3/4	G3/4
Drain pipe		mm	ODΦ20	ODΦ20	ODΦ20	ODΦ20	ODΦ20

Notes:

1. H: High fan speed; M: Medium fan speed; L: Low fan speed.
2. Cooling conditions: Entering water 7°C, leaving water 12°C, Entering air temperature 27°C DB/19°C WB.
Heating conditions: Entering water 45°C, leaving water 40°C, Entering air temperature 20°C DB.
3. Noise is tested in a reverberation chamber test room.

Wall Mounted (P Type)

Model		MKG-250-D	MKG-300-D	MKG-400-D	MKG-500-D	MKG-600-D	
Power supply		V/Ph/Hz 220-240/1/50					
Air flow (H/M/L)		m ³ /h	435/396/342	523/426/351	660/534/480	841/723/594	915/836/714
		CFM	256/233/201	308/251/206	388/314/282	495/425/349	538/492/420
Cooling	Capacity (H/M/L)	kW	1.94/1.84/1.68	2.64/2.4/1.99	2.94/2.58/2.34	4.01/3.61/3.1	4.61/4.33/3.84
	Water flow rate (H/M/L)	m ³ /h	0.35/0.33/0.3	0.47/0.43/0.36	0.53/0.46/0.42	0.72/0.65/0.56	0.83/0.78/0.69
	Water pressure drop (H/M/L)	kPa	31.6/28.6/25.2	37.5/30/24	57.2/47.6/38.7	47.1/33.5/29.7	51/39.5/34
Heating	Capacity (H/M/L)	kW	2.34/2.15/1.94	2.9/2.6/2.22	3.46/2.75/2.52	4.39/3.8/3.27	4.55/4.2/3.82
	Water flow rate (H/M/L)	m ³ /h	0.43/0.39/0.35	0.53/0.47/0.4	0.63/0.5/0.46	0.8/0.69/0.6	0.83/0.76/0.69
	Water pressure drop (H/M/L)	kPa	37.5/34.9/30	40.6/31.5/25	61.9/55.1/46.2	48.6/40.8/31.7	48/43/33
Power input (H/M/L)		W	35/32/31	47/43/39	54/51/47	60/54/48	72/60/55
Auxiliary electric heater (AEH)		W	750	750	750	900	900
Sound pressure level (H/M/L)		dB(A)	30/24/20	35/29/24	37/31/26	39/33/28	40/34/29
Sound power level (H/M/L)		dB(A)	44/42/40	48/43/39	57/51/47	54/50/45	59/55/50
Fan motor	Type	Low noise 3-speed fan motor					
	Quantity	1	1	1	1	1	
Fan	Type	Tangential fan	Tangential fan	Tangential fan	Tangential fan	Tangential fan	
	Quantity	1	1	1	1	1	
Coil	Row	2	2	2	2	2	
	Max. working pressure	MPa	1.6	1.6	1.6	1.6	1.6
	Diameter	mm	Φ7	Φ7	Φ7	Φ7	Φ7
Net dimensions (WxHxD)		mm	915×290×229	915×290×229	915×290×229	1072×315×232	1072×315×232
Packing size (WxHxD)		mm	1020×390×315	1020×390×315	1020×390×315	1180×415×315	1180×415×315
Net weight		kg	13	13	13.3	15.8	15.8
Gross weight		kg	16.3	16.3	16.7	19.4	19.4
Water inlet/outlet pipe		inch	G3/4	G3/4	G3/4	G3/4	G3/4
Drain pipe		mm	ODΦ20	ODΦ20	ODΦ20	ODΦ20	ODΦ20

Notes:

1. H: High fan speed; M: Medium fan speed; L: Low fan speed.
2. Cooling conditions: Entering water 7°C, leaving water 12°C, Entering air temperature 27°C DB/19°C WB.
Heating conditions: Entering water 45°C, leaving water 40°C, Entering air temperature 20°C DB.
3. Noise is tested in a reverberation chamber test room.

2nd Generation Ceiling&Floor series



Model: 150/250/350/500/700/800 CFM



KJRP-86I/MFK-E (Optional)
KJRP-86A/BMFNKD-E(Optional)

Features

- 3 or 4 rows coil are optional for whole series .
- 2-Pipe and 4-Pipe are optional for whole series.
- Ultra-thin with 200 mm thickness.
- Floor standing/Horizontal/ Concealed type installation available (For floor standing: The footing is optional).
- The wired controller(KJRP-86I/MFK-E or KJRP-86A/BMFNKD-E) can be installed inside the unit.

Floor standing unit with multi casing options can be installed quickly and easily in new or existing facilities in a variety of applications.



Multiple Fan Speeds

The AC Series comes with 3 fan speed option to meet the needs of different indoor conditions.

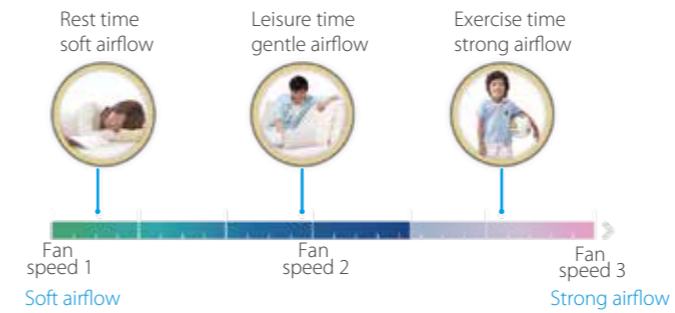

Multiple Appearance Options

The Floor Standing Unit has three appearance options to meet different installation requirement, the H3 (concealed) unit is designed to be concealed in wall while the H1 (front air intake) and H2 (underside air intake) offer a choice of air intake options.

Concealed Type
H3 Series



Exposed Type
(air return from bottom)
H2 Series



Exposed Type
(air return from side)
H1 Series



Control solutions

The fan coil units can be connected to Midea central controllers or BMS through the customized FCU KIT.

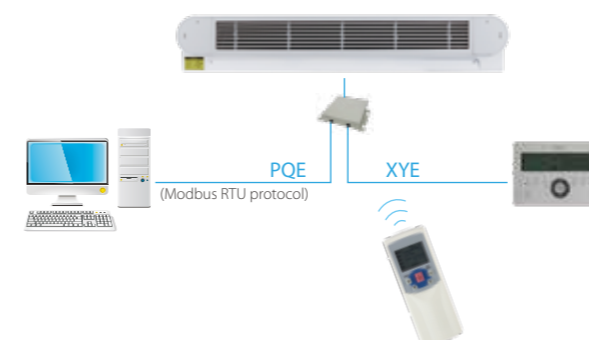

Wired Controller Easy Installation

A place for wired controller is reserved on the surface of the unit, KJRP-86I/MFK-E and KJRP-86A/BMFNKD-E can be perfectly installed.



Right/Left connection easy change

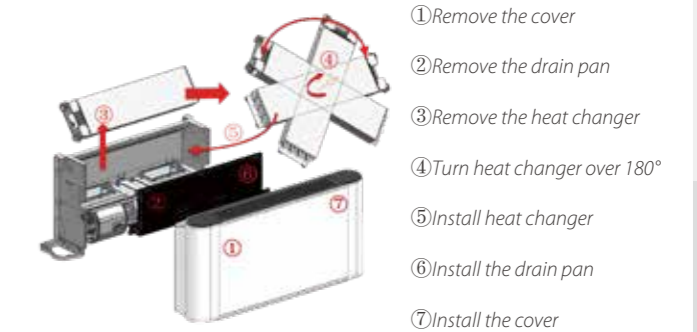

Ease of Installation and Maintenance

The ceiling and floor unit offers exposed installation. The installation and maintenance is easy. The maintenance of the machine is quite easy and the key components can be accessed from the bottom of the machine.



Ceiling and Floor Installation Option

The unit is uniquely designed with the possibility to be installed beneath the ceiling or sitting on the floor to suit any interior design requirements.



2- Pipe 2nd Generation Ceiling&Floor

Model		MKH1-150-R3	MKH1-150-R4	MKH1-250-R3	MKH1-250-R4	MKH1-350-R3	MKH1-350-R4	
Power supply		V/Ph/Hz 220-240/1/50						
Air flow (H/M/L)		m³/h	245/160/135	245/180/130	380/245/140	380/250/160	580/435/310	580/430/310
		CFM	144/94/79	144/106/76	224/144/82	235/147/94	341/256/182	341/253/182
External static pressure		Pa 0						
Cooling	Total Capacity (H/M/L)	kW	1.58/1.17/1.04	2.16/1.78/1.35	2.51/1.92/1.32	2.72/2.02/1.41	3.75/3.10/2.40	4.09/3.29/2.41
	Water flow rate (H/M/L)	m³/h	0.27/0.20/0.18	0.37/0.31/0.23	0.43/0.33/0.23	0.47/0.35/0.24	0.64/0.53/0.41	0.70/0.56/0.41
	Water pressure drop (H/M/L)	kPa	15.1/9.0/7.1	31.9/23.2/14.1	17.1/11.7/5.2	23.9/14.0/7.5	37.3/26.4/16.5	40.1/26.4/15.3
Heating	Capacity (H/M/L)	kW	1.77/1.24/1.08	2.26/1.79/1.36	2.80/2.01/1.38	2.81/2.04/1.43	3.99/3.21/2.41	4.19/3.34/2.45
	Water flow rate (H/M/L)	m³/h	0.30/0.21/0.19	0.39/0.31/0.23	0.48/0.34/0.24	0.48/0.35/0.25	0.68/0.55/0.41	0.72/0.57/0.42
	Water pressure drop (H/M/L)	kPa	15.0/7.9/6.4	31.9/21.5/14.1	16.6/9.8/5.2	22.5/12.6/6.1	34.6/24.2/15.4	36.3/25.4/14.5
Power input (H/M/L)		W	35/17/14	40/24/15	47/26/14	47/26/15	51/32/19	51/32/19
Sound pressure level (H/M/L)		dB(A)	34/23/21	39/34/26	34/25/19	35/26/20	39/32/24	39/32/24
Sound power level (H/M/L)		dB(A)	47/36/34	52/47/39	47/38/32	48/39/33	52/45/37	52/45/37
Fan motor	Type	AC fan motor						
	Quantity	1	1	1	1	1	1	
Fan	Type	Centrifugal, forward-curved Blades						
	Quantity	1	1	2	2	2	2	
Coil	Row	3	4	3	4	3	4	
	Max. working pressure	MPa	1.6	1.6	1.6	1.6	1.6	1.6
	Diameter	mm	Ø7.94	Ø7.94	Ø7.94	Ø7.94	Ø7.94	Ø7.94
Body	Net dimensions (WxHxD)	mm	790x495x211	790x495x211	1020x495x211	1020x495x211	1240x495x211	1240x495x211
	Packing size (WxHxD)	mm	895x595x300	895x595x300	1125x595x300	1125x595x300	1345x595x300	1345x595x300
	Net weight	kg	16.3	16.7	20.0	20.8	24.0	25.4
	Gross weight	kg	21.8	22.7	26.8	26.8	31.0	32.4
Water inlet/outlet pipe		inch	G3/4	G3/4	G3/4	G3/4	G3/4	G3/4
Drain pipe		mm	ODØ18.5	ODØ18.5	ODØ18.5	ODØ18.5	ODØ18.5	ODØ18.5

Model		MKH1-500-R3	MKH1-500-R4	MKH1-700-R3	MKH1-700-R4	MKH1-800-R3	MKH1-800-R4	
Power supply		V/Ph/Hz 220-240/1/50						
Air flow (H/M/L)		m³/h	780/550/380	780/560/390	1050/750/490	1050/800/520	1100/920/660	1050/910/670
		CFM	459/324/224	459/329/229	618/441/288	618/471/306	647/541/388	618/535/394
External static pressure		Pa 0						
Cooling	Total Capacity (H/M/L)	kW	4.59/3.75/2.88	5.21/4.00/3.00	5.29/4.43/3.27	6.16/5.29/3.87	6.22/5.50/4.36	6.66/6.07/4.74
	Water flow rate (H/M/L)	m³/h	0.79/0.64/0.49	0.89/0.71/0.55	0.91/0.76/0.56	1.06/0.91/0.66	1.07/0.94/0.75	1.14/1.04/0.81
	Water pressure drop (H/M/L)	kPa	56.1/39.5/25.0	59.9/40.4/26.0	47.5/32.6/18.7	36.8/26.7/14.8	38.4/31.4/19.7	52.3/44.5/28.2
Heating	Capacity (H/M/L)	kW	5.13/3.90/2.96	5.33/4.25/3.23	5.42/4.50/3.35	6.53/5.30/3.92	6.94/6.00/4.62	6.86/6.13/4.76
	Water flow rate (H/M/L)	m³/h	0.88/0.67/0.51	0.91/0.73/0.55	0.93/0.77/0.57	1.12/0.91/0.67	1.19/1.03/0.79	1.18/1.05/0.82
	Water pressure drop (H/M/L)	kPa	56.0/36.8/23.0	59.4/36.8/21.2	51.0/34.0/18.6	38.5/26.2/13.4	40.7/28.8/17.0	50.0/38.3/23.3
Power input (H/M/L)		W	91/54/34	92/54/35	124/98/68	117/93/66	118/93/65	110/81/70
Sound pressure level (H/M/L)		dB(A)	48/39/30	48/39/30	52/43/33	52/43/33	53/48/39	53/48/39
Sound power level (H/M/L)		dB(A)	61/52/43	61/52/43	65/57/46	65/57/47	66/61/52	65/61/52
Fan motor	Type	AC fan motor						
	Quantity	1	1	1	1	1	1	
Fan	Type	Centrifugal, forward-curved Blades						
	Quantity	2	2	3	3	3	3	
Coil	Row	3	4	3	4	3	4	
	Max. working pressure	MPa	1.6	1.6	1.6	1.6	1.6	1.6
	Diameter	mm	Ø7.94	Ø7.94	Ø7.94	Ø7.94	Ø7.94	Ø7.94
Body	Net dimensions (WxHxD)	mm	1240x495x211	1240x495x211	1360x495x211	1360x495x211	1360x591x211	1360x591x211
	Packing size (WxHxD)	mm	1345x595x300	1345x595x300	1465x595x300	1465x595x300	1465x695x300	1465x695x300
	Net weight	kg	25.5	26.3	27.3	28.5	31.7	34.0
	Gross weight	kg	32.0	33.4	34.8	36.0	40.2	42.0
Water inlet/outlet pipe		inch	G3/4	G3/4	G3/4	G3/4	G3/4	G3/4
Drain pipe		mm	ODØ18.5	ODØ18.5	ODØ18.5	ODØ18.5	ODØ18.5	ODØ18.5

- Notes:
- H: High fan speed; M: Medium fan speed; L: Low fan speed.
 - Cooling conditions: Entering water 7 C, leaving water 12 C, Entering air temperature 27 C DB/19 C WB.
Heating conditions: Entering water 45 C, leaving water 40 C, Entering air temperature 20 C DB/15 C WB.
 - Noise is tested in a reverberation chamber test room.

2- Pipe 2nd Generation Ceiling&Floor

Model		MKH2-150-R3	MKH2-150-R4	MKH2-250-R3	MKH2-250-R4	MKH2-350-R3	MKH2-350-R4	
Power supply		V/Ph/Hz 220-240/1/50						
Air flow (H/M/L)		m³/h	255/165/142	255/192/139	400/273/180	425/284/184	595/447/319	595/450/319
		CFM	150/97/84	150/113/82	235/161/106	250/167/109	350/263/188	350/265/188
External static pressure		Pa 0						
Cooling	Total Capacity (H/M/L)	kW	1.65/1.22/1.09	2.25/1.85/1.40	2.65/2.02/1.40	3.05/2.26/1.58	3.85/3.19/2.46	4.20/3.38/2.48
	Water flow rate (H/M/L)	m³/h	0.28/0.21/0.19	0.39/0.32/0.24	0.45/0.35/0.24	0.52/0.39/0.27	0.66/0.55/0.42	0.72/0.58/0.43
	Water pressure drop (H/M/L)	kPa	15.75/9.33/7.37	33.19/22.37/14.64	18.03/11.18/5.48	26.71/15.66/8.42	38.23/27.11/16.96	41.15/27.07/15.71
Heating	Capacity (H/M/L)	kW	1.85/1.29/1.13	2.35/1.87/1.42	3.05/2.24/1.52	3.15/2.28/1.60	4.10/3.30/2.48	4.30/3.43/2.52
	Water flow rate (H/M/L)	m³/h	0.32/0.22/0.19	0.40/0.32/0.24	0.52/0.38/0.26	0.54/0.39/0.28	0.71/0.57/0.43	0.74/0.59/0.43
	Water pressure drop (H/M/L)	kPa	15.13/8.22/6.64	33.19/22.37/14.64	17.56/10.28/5.43	23.31/12.57/6.11	35.52/24.83/14.91	37.20/24.50/13.75
Power input (H/M/L)		W	35/17/14	40/24/15	47/26/14	47/26/14	51/32/19	51/32/19
Sound pressure level (H/M/L)		dB(A)	35/24/21	42/35/27	34/24/18	34/25/19	39/32/23	40/35/31
Sound power level (H/M/L)		dB(A)	47/35/34	53/47/39	46/37/31	47/38/32	52/44/36	52/45/37
Fan motor	Type	AC fan motor						
	Quantity	1	1	1	1	1	1	
Fan	Type	Centrifugal, forward-curved Blades						
	Quantity	1	1	2	2	2	2	
Coil	Row	3	4	3	4	3	4	
	Max. working pressure	MPa	1.6	1.6	1.6	1.6	1.6	1.6
	Diameter	mm	Ø7.94	Ø7.94	Ø7.94	Ø7.94	Ø7.94	Ø7.94
Body	Net dimensions (WxHxD)	mm	790x495x200	790x495x200	1020x495x200	1020x495x200	1240x495x200	1240x495x200
	Packing size (WxHxD)	mm	895x595x300	895x595x300	1125x595x300	1125x595x300	1345x595x300	1345x595x300
	Net weight	kg	16.3	16.7	20.0	20.8	24.0	25.4
	Gross weight	kg	21.8	22.7	26.8	26.8	31.0	32.4
Water inlet/outlet pipe		inch	G3/4	G3/4	G3/4	G3/4	G3/4	G3/4
Drain pipe		mm	ODØ18.5	ODØ18.5	ODØ18.5	ODØ18.5	ODØ18.5	ODØ18.5

Model		MKH2-500-R3	MKH2-500-R4	MKH2-700-R3	MKH2-700-R4	MKH2-800-R3	MKH2-800-R4	
Power supply		V/Ph/Hz 220-240/1/50						
Air flow (H/M/L)		m³/h	790/560/392	800/574/404	1190/855/555	1150/885/591	1300/1088/782	1300/1132/836
		CFM	465/330/231	471/338/238	700/503/327	677/521/348	766/641/461	766/667/492
External static pressure		Pa 0						
Cooling	Total Capacity (H/M/L)	kW	4.65/3.80/2.92	5.35/4.25/3.31	6.00/5.03/3.71	6.75/5.80/4.24	7.35/6.51/5.15	8.25/7.52/5.87
	Water flow rate (H/M/L)	m³/h	0.80/0.65/0.50	0.92/0.73/0.57	1.03/0.86/0.64	1.16/1.00/0.73	1.26/1.12/0.88	1.41/1.29/1.01
	Water pressure drop (H/M/L)	kPa	56.85/40.02/25.31	61.48/41.44/26.62	53.79/36.96/21.16	40.26/29.20/16.15	45.43/37.06/23.29	64.72/55.03/34.88
Heating	Capacity (H/M/L)	kW	5.20/3.95/3.00	5.70/4.36/3.31	6.15/5.10/3.80	7.15/5.81/4.30	8.20/7.09/5.46	8.50/7.60/5.90
	Water flow rate (H/M/L)	m³/h	0.89/0.68/0.52	0.98/0.75/0.57	1.05/0.88/0.65	1.23/1.00/0.74	1.41/1.22/0.94	1.46/1.30/1.02
	Water pressure drop (H/M/L)	kPa	56.68/37.31/23.25	60.89/37.73/21.79	57.85/38.53/21.1	42.16/28.68/14.66	44.60/34.09/19.98	61.96/47.46/28.84
Power input (H/M/L)		W	91/54/34	91/54/35	123/98/68	110/89/64	123/109/83	118/104/82
Sound pressure level (H/M/L)		dB(A)	48/39/31	47/40/31	50/43/33	50/44/33	51/46/36	50/45/37
Sound power level (H/M/L)		dB(A)	59/51/43	59/51/43	64/56/45	62/56/46	63/58/50	63/58/50
Fan motor	Type	AC fan motor						
	Quantity	1	1	1	1	1	1	
Fan	Type	Centrifugal, forward-curved Blades						
	Quantity	2	2	3	3	3	3	
Coil	Row	3	4	3	4	3	4	
	Max. working pressure	MPa	1.6	1.6	1.6	1.6	1.6	1.6
	Diameter	mm	Ø7.94	Ø7.94	Ø7.94	Ø7.94	Ø7.94	Ø7.94
Body	Net dimensions (WxHxD)	mm	1240x495x200	1240x495x200	1360x495x200	1360x495x200	1360x591x200	1360x591x200
	Packing size (WxHxD)	mm	1345x595x300	1345x595x300	1465x595x300	1465x595x300	1465x695x300	1465x695x300
	Net weight	kg	25.5	26.3	27.3	28.5	31.7	34.0
	Gross weight	kg	32.0	33.4	34.8	36.0	40.2	42.0
Water inlet/outlet pipe		inch	G3/4	G3/4	G3/4	G3/4	G3/4	G3/4
Drain pipe		mm	ODØ18.5	ODØ18.5	ODØ18.5	ODØ18.5	ODØ18.5	ODØ18.5

- Notes:
- H: High fan speed; M: Medium fan speed; L: Low fan speed.
 - Cooling conditions: Entering water 7 C, leaving water 12 C, Entering air temperature 27 C DB/19 C WB.
Heating conditions: Entering water 45 C, leaving water 40 C, Entering air temperature 20 C DB/15 C WB.
 - Noise is tested in a reverberation chamber test room.

Model		MKH3-150-R3	MKH3-150-R4	MKH3-250-R3	MKH3-250-R4	MKH3-350-R3	MKH3-350-R4	
Power supply		V/Ph/Hz 220-240/1/50						
Air flow (H/M/L)		m³/h	255/165/142	255/192/139	400/273/180	425/284/184	595/447/319	595/450/319
		CFM	150/97/84	150/113/82	235/161/106	250/167/109	350/263/188	350/265/188
External static pressure		Pa 12						
Cooling	Total Capacity (H/M/L)	kW	1.65/1.22/1.09	2.25/1.85/1.40	2.65/2.02/1.40	3.05/2.26/1.58	3.85/3.19/2.46	4.20/3.38/2.48
	Water flow rate (H/M/L)	m³/h	0.28/0.21/0.19	0.39/0.32/0.24	0.45/0.35/0.24	0.52/0.39/0.27	0.66/0.55/0.42	0.72/0.58/0.43
	Water pressure drop (H/M/L)	kPa	15.75/9.33/7.37	33.19/22.37/14.64	18.03/11.18/5.48	26.71/15.66/8.42	38.23/27.11/16.96	41.15/27.07/15.71
Heating	Capacity (H/M/L)	kW	1.85/1.29/1.13	2.35/1.87/1.42	3.05/2.24/1.52	3.15/2.28/1.60	4.10/3.30/2.48	4.30/3.43/2.52
	Water flow rate (H/M/L)	m³/h	0.32/0.22/0.19	0.40/0.32/0.24	0.52/0.38/0.26	0.54/0.39/0.28	0.71/0.57/0.43	0.74/0.59/0.43
	Water pressure drop (H/M/L)	kPa	15.13/8.22/6.64	33.19/22.37/14.64	17.56/10.28/5.43	23.31/12.57/6.11	35.52/24.83/14.91	37.20/24.50/13.75
Power input (H/M/L)		W	35/17/14	40/24/15	47/26/14	47/26/14	51/32/19	51/32/19
Sound pressure level (H/M/L)		dB(A)	35/24/21	42/35/27	34/24/18	34/25/19	39/32/23	40/35/31
Sound power level (H/M/L)		dB(A)	47/35/34	53/47/39	46/37/31	47/38/32	52/44/36	52/45/37
Fan motor		AC fan motor						
Type		Centrifugal, forward-curved Blades						
Quantity		1	1	1	1	1	1	
Fan		Centrifugal, forward-curved Blades						
Type		Centrifugal, forward-curved Blades						
Quantity		1	1	2	2	2	2	
Row		3	4	3	4	3	4	
Coil		Centrifugal, forward-curved Blades						
Max. working pressure		MPa	1.6	1.6	1.6	1.6	1.6	
Diameter		mm	Ø7.94	Ø7.94	Ø7.94	Ø7.94	Ø7.94	
Body		Centrifugal, forward-curved Blades						
Net dimensions (WxHxD)		mm	596x455x200	596x455x200	826x455x200	826x455x200	1046x455x200	1046x455x200
Packing size (WxHxD)		mm	755x555x255	755x555x255	985x555x255	985x555x255	1205x555x255	1205x555x255
Net weight		kg	11.6	12.0	13.9	14.8	17.3	18.2
Gross weight		kg	15.9	16.3	19.4	20.3	24.0	24.9
Water inlet/outlet pipe		inch	G3/4	G3/4	G3/4	G3/4	G3/4	G3/4
		mm	ODØ18.5	ODØ18.5	ODØ18.5	ODØ18.5	ODØ18.5	ODØ18.5

Model		MKH3-500-R3	MKH3-500-R4	MKH3-700-R3	MKH3-700-R4	MKH3-800-R3	MKH3-800-R4	
Power supply		V/Ph/Hz 220-240/1/50						
Air flow (H/M/L)		m³/h	790/560/392	800/574/404	1190/855/555	1150/885/591	1300/1088/782	1300/1132/836
		CFM	465/330/231	471/338/238	700/503/327	677/521/348	766/641/461	766/667/492
External static pressure		Pa 12						
Cooling	Total Capacity (H/M/L)	kW	4.65/3.80/2.92	5.35/4.25/3.31	6.00/5.03/3.71	6.75/5.80/4.24	7.35/6.51/5.15	8.25/7.52/5.87
	Water flow rate (H/M/L)	m³/h	0.80/0.65/0.50	0.92/0.73/0.57	1.03/0.86/0.64	1.16/1.00/0.73	1.26/1.12/0.88	1.41/1.29/1.01
	Water pressure drop (H/M/L)	kPa	56.85/40.02/25.31	61.48/41.44/26.62	53.79/36.96/21.16	40.26/29.20/16.15	45.43/37.06/23.29	64.72/55.03/34.88
Heating	Capacity (H/M/L)	kW	5.20/3.95/3.00	5.70/4.36/3.31	6.15/5.10/3.80	7.15/5.81/4.30	8.20/7.09/5.46	8.50/7.60/5.90
	Water flow rate (H/M/L)	m³/h	0.89/0.68/0.52	0.98/0.75/0.57	1.05/0.88/0.65	1.23/1.00/0.74	1.41/1.22/0.94	1.46/1.30/1.02
	Water pressure drop (H/M/L)	kPa	56.68/37.31/23.25	60.89/37.73/21.79	57.85/38.53/21.1	42.16/28.68/14.66	44.60/34.09/19.98	61.96/47.46/28.84
Power input (H/M/L)		W	91/54/34	91/54/35	123/98/68	110/89/64	123/109/83	118/104/82
Sound pressure level (H/M/L)		dB(A)	48/39/31	47/40/31	50/43/33	50/44/33	51/46/36	50/45/37
Sound power level (H/M/L)		dB(A)	59/51/43	59/51/43	64/56/45	62/56/46	63/58/50	63/58/50
Fan motor		AC fan motor						
Type		Centrifugal, forward-curved Blades						
Quantity		1	1	1	1	1	1	
Fan		Centrifugal, forward-curved Blades						
Type		Centrifugal, forward-curved Blades						
Quantity		2	2	3	3	3	3	
Row		3	4	3	4	3	4	
Coil		Centrifugal, forward-curved Blades						
Max. working pressure		MPa	1.6	1.6	1.6	1.6	1.6	
Diameter		mm	Ø7.94	Ø7.94	Ø7.94	Ø7.94	Ø7.94	
Body		Centrifugal, forward-curved Blades						
Net dimensions (WxHxD)		mm	1046x455x200	1046x455x200	1166x455x200	1166x455x200	1166x455x200	1166x455x200
Packing size (WxHxD)		mm	1205x555x255	1205x555x255	1325x555x255	1325x555x255	1325x650x255	1325x650x255
Net weight		kg	17.9	18.8	20.5	21.7	24.0	25.2
Gross weight		kg	24.6	25.5	27.3	28.5	31.1	32.3
Water inlet/outlet pipe		inch	G3/4	G3/4	G3/4	G3/4	G3/4	G3/4
Drain pipe		mm	ODØ18.5	ODØ18.5	ODØ18.5	ODØ18.5	ODØ18.5	ODØ18.5

Notes:

- H: High fan speed; M: Medium fan speed; L: Low fan speed.
- Cooling conditions: Entering water 7°C, leaving water 12°C, Entering air temperature 27°C DB/19°C WB.
Heating conditions: Entering water 45°C, leaving water 40°C, Entering air temperature 20°C DB/15°C WB.
- Noise is tested in a reverberation chamber test room.
- H3 series test with concealed tooling.

4-Pipe 2nd Generation Ceiling&Floor

Model		MKH1-150F-R4	MKH1-250F-R4	MKH1-350F-R4	MKH1-500F-R4	MKH1-700F-R4	MKH1-800F-R4	
Power supply		V/Ph/Hz 220-240/1/50						
Air flow (H/M/L)		m³/h	245/180/130	380/250/160	580/430/310	780/560/390	1050/800/520	1050/910/670
		CFM	144/106/76	224/147/94	341/253/182	459/329/229	618/471/306	618/535/394
External static pressure		Pa 0						
Cooling	Total Capacity (H/M/L)	kW	1.87/1.54/1.10	2.58/1.83/1.12	3.99/3.27/2.29	4.92/3.95/3.12	5.84/5.10/3.65	6.18/5.65/4.44
	Water flow rate (H/M/L)	m³/h	0.321/0.26/0.19	0.44/0.31/0.19	0.68/0.56/0.39	0.84/0.68/0.54	1.00/0.87/0.63	1.06/0.97/0.76
	Water pressure drop (H/M/L)	kPa	26.4/18.0/11.5	19.1/10.7/4.5	46.5/32.2/17.8	69.3/46.6/31.2	57.6/44.3/24.9	40.8/35.3/22.8
Heating	Capacity (H/M/L)	kW	1.62/1.35/1.10	2.19/1.52/1.06	2.88/2.44/1.95	3.55/2.97/2.44	4.25/3.74/2.91	5.90/5.8/5.05
	Water flow rate (H/M/L)	m³/h	0.14/0.12/0.10	0.19/0.13/0.09	0.25/0.21/0.17	0.31/0.26/0.21	0.37/0.32/0.25	0.51/0.50/0.44
	Water pressure drop (H/M/L)	kPa	15.0/10.6/7.7	28.6/15.1/8.5	56.7/42.3/28.5	80.0/59.8/41.8	123.45/102.03/64.74	54.8/53.1/43.3
Power input (H/M/L)		W	40/24/15	47/26/15	51/32/19	92/54/35	117/93/66	110/81/70
Sound pressure level (H/M/L)		dB(A)	39/34/26	35/26/20	39/32/24	48/39/30	52/43/34	52/48/39
Sound power level (H/M/L)		dB(A)	52/47/39	48/39/33	52/45/37	61/52/43	65/57/47	65/61/52
Fan motor		AC fan motor						
Type		Centrifugal, forward-curved Blades						
Quantity		1	1	1	1	1	1	
Fan		Centrifugal, forward-curved Blades						
Type		Centrifugal, forward-curved Blades						
Quantity		1	2	2	2	3	3	
Row		4	4	4	4	4	4	
Coil		Centrifugal, forward-curved Blades						
Max. working pressure		MPa	1.6	1.6	1.6	1.6	1.6	
Diameter		mm	Ø7.94	Ø7.94	Ø7.94	Ø7.94	Ø7.94	
Body		Centrifugal, forward-curved Blades						
Net dimensions (WxHxD)		mm	790x495x211	1020x495x211	1240x495x211	1240x495x211	1360x495x211	1360x591x211
Packing size (WxHxD)		mm	895x595x300	1125x595x300	1345x595x300	1345x595x300	1465x595x300	1465x695x300
Net weight		kg	17.2	21.3	25.9	26.8	29.0	34.5
Gross weight		kg	23.2	27.3	32.9	33.9	36.5	42.5
Water inlet/outlet pipe		inch	Cold water: G3/4; Hot water: G1/2					
Drain pipe		mm	ODØ18.5	ODØ18.5	ODØ18.5	ODØ18.5	ODØ18.5	ODØ18.5

Model		MKH2-150F-R4	MKH2-250F-R4	MKH2-350F-R4	MKH2-500F-R4	MKH2-700F-R4	MKH2-800F-R4	
Power supply		V/Ph/Hz 220-240/1/50						
Air flow (H/M/L)		m³/h	255/192/139	425/284/184	595/450/319	800/574/404	1150/885/591	1300/1132/836
		CFM	150/113/82	250/167/109	350/265/188	471/338/238	677/521/348	766/667/492
External static pressure		Pa 0						
Cooling	Sensible Capacity (H/M/L)	kW	1.50/1.20/0.78	2.05/1.39/0.84	2.94/2.38/1.60	3.80/2.95/2.25	4.90/4.25/2.95	5.85/5.28/4.05
	Total Capacity (H/M/L)	kW	1.95/1.60/1.15	2.89/2.05/1.25	4.09/3.35/2.35	5.05/4.05/3.20	6.40/5.59/4.00	7.65/7.00/5.50
	Water flow rate (H/M/L)	m³/h	0.33/0.28/0.20	0.50/0.35/0.21	0.70/0.57/0.40	0.87/0.69/0.55	1.10/0.96/0.69	1.31/1.20/0.94
	Water pressure drop (H/M/L)	kPa	27.47/19.63/12.54	21.38/11.95/4.99	47.7/33.04/18.22	71.09/47.81/31.95	63.05/48.47/27.23	50.47/43.72/28.23
Heating	Capacity (H/M/L)	kW	1.69/1.40/1.15	2.45/1.70/1.19	2.95/2.50/2.00	3.46/3.05/2.50	4.65/4.09/3.19	7.30/7.19/6.25
	Water flow rate (H/M/L)	m³/h	0.14/0.12/0.10	0.21/0.15/0.10	0.25/0.21/0.17	0.31/0.26/0.21	0.40/0.35/0.27	0.63/0.62/0.54
	Water pressure drop (H/M/L)	kPa	15.60/11.01/8.04	31.95/16.83/9.52	58.17/43.35/29.20	82.01/61.29/42.87	135.21/111.75/70.91	67.86/65.78/53.61
Power input (H/M/L)		W	40/24/15	47/26/14	51/32/19	91/54/35	110/89/64	118/104/82
Rated current		A	0.17/0.10/0.07	0.20/0.11/0.06	0.22/0.14/0.08	0.40/0.24/0.15	0.48/0.39/0.28	0.51/0.45/0.36
Sound pressure level (H/M/L)		dB(A)	42/35/27	34/25/19	40/33/24	47/40/31	50/44/33	50/45/37
Sound power level (H/M/L)		dB(A)	53/47/39	47/38/32	52/45/37	59/51/43	62/56/46	63/58/50
Fan motor		AC fan motor						
Type		Centrifugal, forward-curved Blades						
Quantity		1	1	1	1	1	1	
Fan		Centrifugal, forward-curved Blades						
Type		Centrifugal, forward-curved Blades						
Quantity		1	2	2	2	3	3	
Row		4	4	4	4	4	4	
Coil		Centrifugal, forward-curved Blades						
Max. working pressure		MPa	1.6	1.6	1.6	1.6	1.6	
Diameter		mm	Ø7.94	Ø7.94	Ø7.94	Ø7.94	Ø7.94	
Body		Centrifugal, forward-curved Blades						
Net dimensions (WxHxD)		mm	790x495x200	1020x495x200	1240x495x200	1240x495x200	1360x495x200	1360x591x200
Packing size (WxHxD)		mm	895x595x300	1125x595x300	1345x595x300	1345x595x300	1465x595x300	1465x695x300
Net weight		kg	17.2	21.3	25.9	26.8	29.0	34.5
Gross weight		kg	23.2	27.3	32.9	33.9	36.5	42.5
Water inlet/outlet pipe		inch	G3/4	G3/4	G3/4	G3/4	G3/4	G3/4
Drain pipe		mm	ODØ18.5	ODØ18.5	ODØ18.5	ODØ18.5	ODØ18.5	ODØ18.5

Notes:

- H: High fan speed; M: Medium fan speed; L: Low fan speed.
- Cool

Model		MKH3-150F-R4	MKH3-250F-R4	MKH3-350F-R4	MKH3-500F-R4	MKH3-700F-R4	MKH3-800F-R4	
Power supply	V/Ph/Hz	220-240/1/50						
Air flow (H/M/L)	m ³ /h	255/192/139	425/284/184	595/450/319	800/574/404	1150/885/591	1300/1132/836	
	CFM	150/113/82	250/167/109	350/265/188	471/338/238	677/521/348	766/667/492	
External static pressure	Pa	12						
Cooling	Sensible Capacity (H/M/L)	kW	1.50/1.20/0.78	2.05/1.39/0.84	2.94/2.38/1.60	3.80/2.95/2.25	4.90/4.25/2.95	5.85/5.28/4.05
	Total Capacity (H/M/L)	kW	1.95/1.60/1.15	2.89/2.05/1.25	4.09/3.35/2.35	5.05/4.05/3.20	6.40/5.59/4.00	7.65/7.00/5.50
	Water flow rate (H/M/L)	m ³ /h	0.33/0.28/0.20	0.50/0.35/0.21	0.70/0.57/0.40	0.87/0.69/0.55	1.10/0.96/0.69	1.31/1.20/0.94
	Water pressure drop (H/M/L)	kPa	27.47/19.63/12.54	21.38/11.95/4.99	47.7/33.04/18.22	71.09/47.81/31.95	63.05/48.47/27.23	50.47/43.72/28.23
Heating	Capacity (H/M/L)	kW	1.69/1.40/1.15	2.45/1.70/1.19	2.95/2.50/2.00	3.46/3.05/2.50	4.65/4.09/3.19	7.30/7.19/6.25
	Water flow rate (H/M/L)	m ³ /h	0.14/0.12/0.10	0.21/0.15/0.10	0.25/0.21/0.17	0.31/0.26/0.21	0.40/0.35/0.27	0.63/0.62/0.54
	Water pressure drop (H/M/L)	kPa	15.60/11.01/8.04	31.95/16.83/9.52	58.17/43.35/29.20	82.01/61.29/42.87	135.21/111.75/70.91	67.86/65.78/53.61
Power input	(H/M/L)	W	40/24/15	47/26/14	51/32/19	91/54/35	110/89/64	118/104/82
Sound pressure level	(H/M/L)	dB(A)	42/35/27	34/25/19	40/33/24	47/40/31	50/44/33	50/45/37
Sound power level	(H/M/L)	dB(A)	53/47/39	47/38/32	52/45/37	59/51/43	62/56/46	63/58/50
Rated current	A	0.17/0.10/0.07	0.20/0.11/0.06	0.22/0.14/0.08	0.40/0.24/0.15	0.48/0.39/0.28	0.51/0.45/0.36	
Fan motor	Type	AC fan motor						
	Quantity	1	1	1	1	1	1	
Fan	Type	Centrifugal, forward-curved Blades						
	Quantity	1	2	2	2	3	3	
Coil	Row	4	4	4	4	4	4	
	Max. working pressure	MPa	1.6	1.6	1.6	1.6	1.6	1.6
	Diameter	mm	Φ7.94	Φ7.94	Φ7.94	Φ7.94	Φ7.94	Φ7.94
Body	Net dimensions (WxHxD)	mm	596x455x200	826x455x200	1046x455x200	1046x455x200	1166x455x200	1166x455x200
	Packing size (WxHxD)	mm	895x595x300	1125x595x300	1345x595x300	1345x595x300	1465x595x300	1465x695x300
	Net weight	kg	12.5	15.3	18.7	19.3	22.2	25.7
	Gross weight	kg	16.8	20.8	25.4	26.0	29.0	32.8
Water inlet/outlet pipe	inch	Cold water: G3/4; Hot water: G1/2						
Drain pipe	mm	ODΦ18.5						

Notes:

1. H: High fan speed; M: Medium fan speed; L: Low fan speed.
2. Cooling conditions: Entering water 7°C, leaving water 12°C, Entering air temperature 27°C DB/19°C WB.
Heating conditions: Entering water 65°C, leaving water 55°C, Entering air temperature 20°C DB/15°C WB.
3. Noise is tested in a reverberation chamber test room.
4. H3 series test with concealed tooling.



DC Fan Coil Units





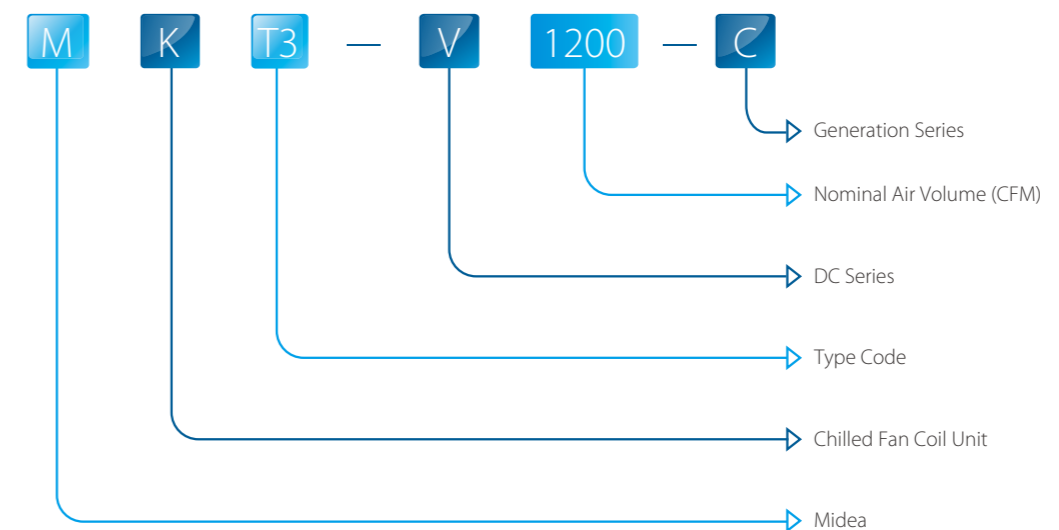

Midea DC Fan Coil Units operate in high efficiency and low sound level due to the DC brushless fan motor. It contains cassette units, ceiling & floor units with or without cabinet, wall-mounted units and duct units. The air volume ranges from 150CFM to 1500CFM. It is a highly versatile product suitable for hospitals, office buildings, hotels, airports and various other applications.

Nomenclature







Product Lineup

2-Pipe FCUs

Model		150	200	250	300	350	400	450	500		600	700	750	800	850	900	950	1000	1200	1400	1500	
1-way cassette					⊙		⊙				⊙											
4-way cassette											⊙		⊙		⊙		⊙		⊙			⊙
New 4-way cassette											⊙	⊙		⊙					⊙	⊙		
Compact 4-way cassette					⊙		⊙		⊙													
Duct			⊙		⊙		⊙		⊙		⊙	⊙		⊙					⊙	⊙	⊙	
Wall mounted				⊙	⊙		⊙		⊙		⊙											
2 nd generation Ceiling&floor		⊙		⊙		⊙			⊙			⊙		⊙								

4-Pipe FCUs

Model		150	200	250	300	350	400	500		600	700	750	800	850	950	1000	1200	1500
4-way cassette										⊙		⊙		⊙	⊙		⊙	⊙
New 4-way cassette										⊙	⊙		⊙			⊙	⊙	
Compact 4-way cassette					⊙		⊙	⊙										
2 nd generation Ceiling&floor		⊙		⊙		⊙		⊙			⊙		⊙					
Duct			⊙		⊙		⊙	⊙		⊙			⊙				⊙	⊙

Notes:
The standard power supply for all fan coil units is 220V-240V/50Hz; 208-230V/60Hz can be customized for some series fan coil units. For further information, please contact with our salesmen.

DC Series Functions

Functions			One-way Cassette	Compact Four-way Cassette	Four-way Cassette	Wall Mounted	2 nd Generation Ceiling & Floor	Duct
Control Customization	Follow me	With the follow me function, the indoor unit responds to the temperature measured by the temperature sensor built-in the wireless remote controller.	○(KJR-29B)	○(KJR-29B)	○(KJR-29B)	○(KJR-29B)	○(KJR-29B)	×
	Anti cold air	Prevent the unit from cold supply air when starting in winter.	●	●	●	●	●	× ●(MKT3-C)
	Auto-restart	The unit restarts automatically with the previous settings after power failure.	●	●	●	●	●	× ●(MKT3-C)
	Forced fan running	After reaching the set temperature, the valve body closes and the fan operates according to the setting.	√	○	√	√	√	× ●(MKT3-C)
	Heat	Only electric auxiliary heating.	×	×	×	×	×	× √ (Wired controller setting, MKT3-C)
	Temperature compensation	Heating mode: $T_2 = T_1 + \Delta T$; Cooling mode: $T_2 = T_1 - \Delta T$ T2: Indoor Temperature, T1: Setting Temperature, ΔT : Temperature Compensation	√	○	√	√	√	×
	XYE Port	Communicate with central controllers or BMS.	○(XYE)	○(XYE)	○(XYE)	●	○(XYE)	○(FCU-kit) ○(MKT3-C)
	PQE Port	Communicate with Modbus.	○	○	○	○	○	×
	CCM18/CCM08/CCM15/BMS/IMM	Central controllers and BMS.	○(XYE)	○(XYE)	○(XYE)	●	○(XYE)	○(FCU-kit) ○(XYE, MKT3-C)
	0-10V output control	By outputting a 0-10 V level, the opening of the valve body is controlled to meet different energy requirements.	×	×	○(New Four-way Cassette) ×	○	×	× ○(MKT3-C)
	0-10V input control	By inputting a 0-10 V level to PCB, the fan motor speed is controlled to meet different energy requirements.	○	×	○	○	○	× ○(MKT3-C)
Structure Customization	Right/Left piping connection	Left and right hand piping connections are optional, flexible installation.	×	×	×	×	●	●
	Electric auxiliary heating	Increase heating capacity with additional electric heater.	×	×	○	×	×	× ○(MKT3-C)
	Extended drainage pan	Drainage pan accessory.	×	×	×	×	×	○
	Auxiliary drainage pan		×	○	○	×	○	○ × (MKT3-C)

Note:
●: equipped as standard; ○: customization option; ×: without this function; √: switch setting

Advantage of Fan Coil Units with

DC Brushless Fan Motor

The DC fan coil units are the new energy saving products improved with advanced DC driven technology. The DC fan coil units have advanced technology of high energy efficiency, low noise operation and precise temperature control, so are ideal for hospitals, office building, hotels, airports and various other applications.



DC driven motor

Energy Efficiency, Comply with CE Regulation

The power consumption of DC driven fan coil units can be reduced up to 30% in comparison to corresponding AC type.

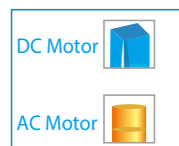
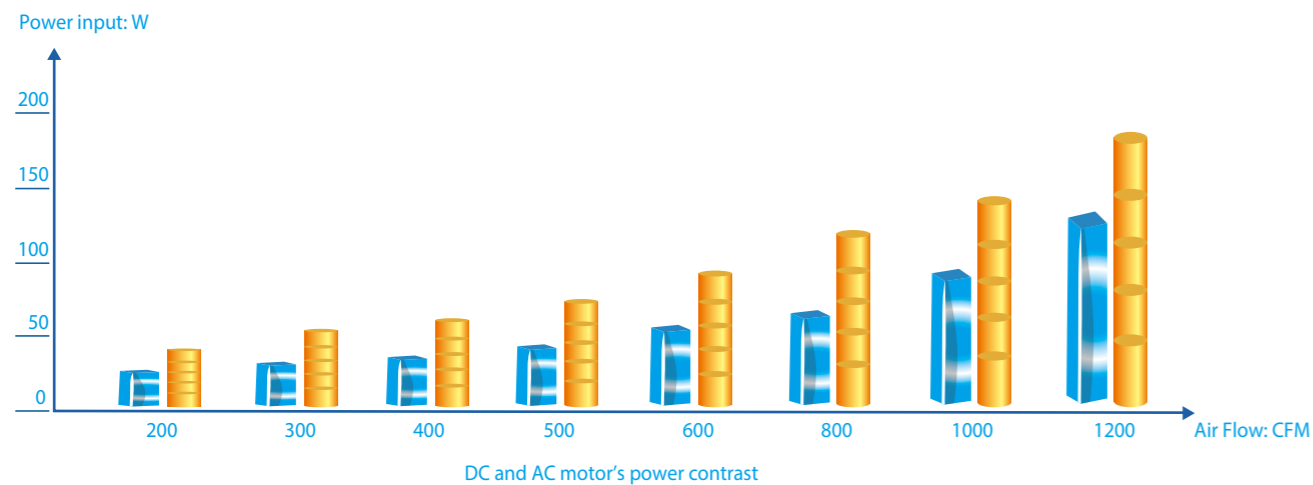

Quiet Operation

Unit noise is 2-5dB(A) lower compared to an AC motor fan coil unit, creating a quiet living environment.



Constant Level of Air Temperature and Humidity

The DC Inverter fan motor adjusts air flow based on thermal load instantly providing less temperature fluctuation and an improved living environment.

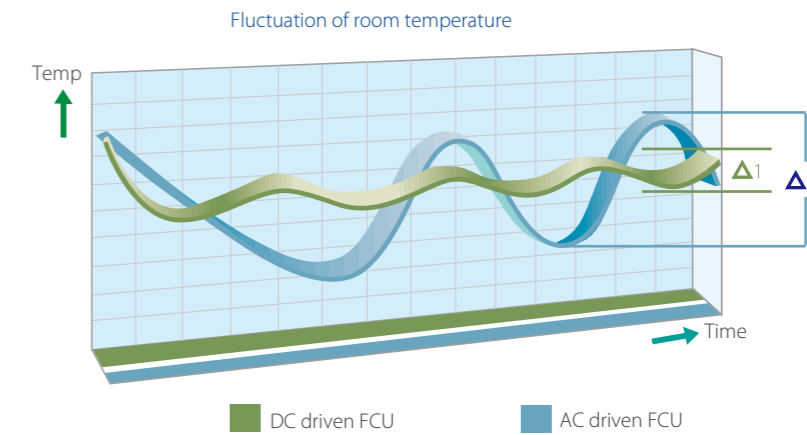

Versatile Selection

Midea DC Fan Coil Units contain cassette units, ceiling & floor units with or without cabinet, wall-mounted units and duct units. The air volume ranges from 150CFM to 1500CFM. It is a highly versatile product suitable for hospitals, office buildings, hotels, airports and various other applications.

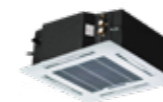

Cassette unit



Wall-mounted unit



Duct unit



2nd Generation Ceiling&Floor



1-way cassette

One-way Cassette



Model: 300/400/600 CFM



RM05 Standard



KJR-75A Optional

Features

- Auto mode and 7 fan speed (by 75A wired controller).
- Hysteresis temperature can be set in heating and cooling mode by PCB switch, field adjustable.
- With/without forced fan on can be set by PCB switch, field adjustable.
- The central controller can be connected through the customization XYE port.
- Remote on/off function can be applied to turn on/off the unit.
- The Gateway(Modbus) can be connected through the customization PQE port.
- Wired controller KJR-75A is optional.
- Compatible with 0-10V control function.

One way cassette has a compact size, it's suitable for application in narrow space such as the aisle, small office, elevator space etc.



Multiple Fan Speeds

The DC Series comes with 3 fan speed option to meet the needs of different indoor conditions. (7 fan speed should be used KJR-75A wired controller)

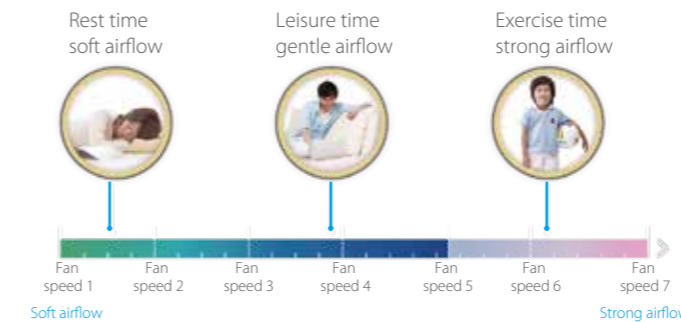

One Direction Air Flow

One direction air flow guarantees quick cooling, flexible installation positioning.

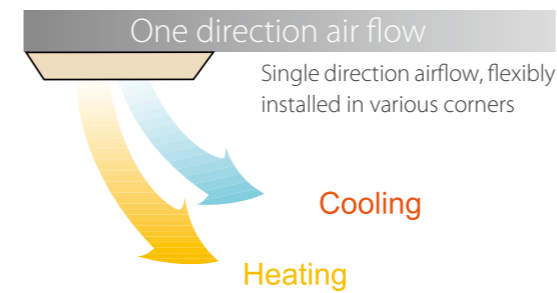

Control solutions

The fan coil units can be connected to Midea central controllers through the customized XYE port, also can be connected to Modbus gateway through the customized PQE port with Modbus RTU protocol.

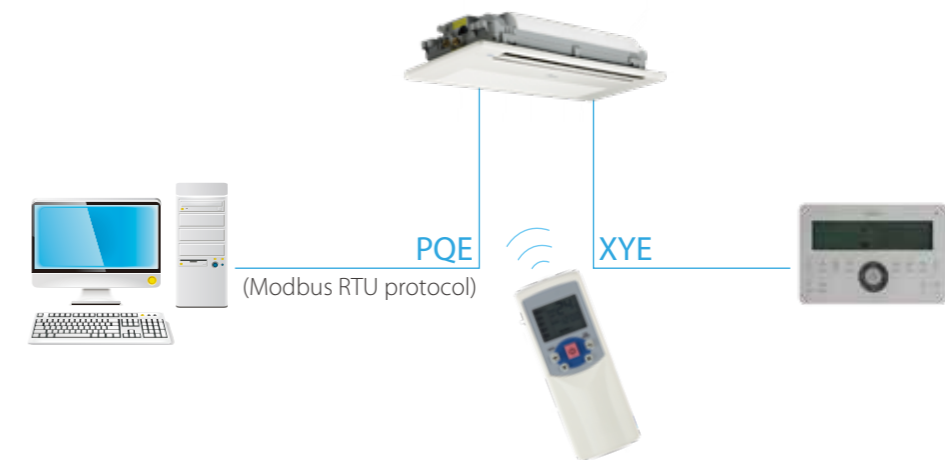

High-lift Pump

Standard built-in drain pump with 750mm pump head.

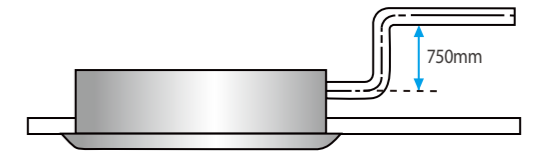

Minimum 153 mm thickness

Compact design, ultra slim body with a minimum thickness of 153mm, especially suitable for narrow ceiling, such as in lobbies and small meeting rooms.



Auto restart

In the event of a sudden power failure during operation, unit restarts automatically and the unit will operate based on the previous setting (operating mode, temperature setting and fan speed).

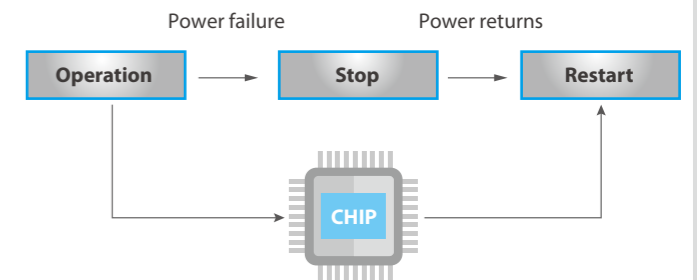

Model			MKC-V300R-B	MKC-V400R-B	MKC-V600R-B
Power supply		V/Ph/Hz	220-240/1/50		
Air flow (H/M/L)		m ³ /h	510/432/330	630/509/428	1000/786/583
		CFM	300/254/194	371/299/252	588/462/343
Cooling	Capacity (H/M/L)	kW	2.65/2.23/1.68	3.78/3.43/2.90	5.20/4.36/3.58
	Water flow rate (H/M/L)	m ³ /h	0.49/0.42/0.33	0.6/0.52/0.45	0.87/0.7/0.55
	Water pressure drop (H/M/L)	kPa	8.63/6.26/3.69	23.85/18.07/14.8	38.22/28.95/19.41
	Power input (H/M/L)	W	22/18/14	25/19/17	38/27/19
Heating	Capacity (H/M/L)	kW	3.15/2.83/2.29	4/3.32/2.73	5.75/4.68/3.6
	Water flow rate (H/M/L)	m ³ /h	0.5/0.42/0.32	0.59/0.49/0.42	0.86/0.67/0.48
	Water pressure drop (H/M/L)	kPa	13.49/9.95/6.84	23.62/20.33/15.89	45.56/32.26/18.92
	Power input (H/M/L)	W	16/11/8	25/12/10	31/20/12
Sound pressure level (H/M/L)		dB(A)	44.3/40.6/33.5	36.6/32.6/30.4	44.6/38.6/33.1
Sound power level (H/M/L)		dB(A)	54/50/43	48/43/40	56/50/44
Fan motor	Type		DC motor	DC motor	DC motor
	Quantity		1	1	1
Fan	Type		Centrifugal, forward-curved Blades		
	Quantity		1	1	1
Coil	Row		2	2	2
	Max. working pressure	MPa	1.6	1.6	1.6
	Diameter	mm	∅7	∅7	∅7
Panel	Net dimensions (WxHxD)	mm	1180x25x465	1350x25x505	1350x25x505
	Packing size (WxHxD)	mm	1232x107x517	1410x95x560	1410x95x560
	Net weight	kg	3.5	4	4
	Gross weight	kg	5.2	5.4	5.4
Body	Net dimensions (WxHxD)	mm	1054x153x428	1275x189x450	1275x189x450
	Packing size (WxHxD)	mm	1155x245x490	1400x295x505	1400x295x505
	Net weight	kg	12.5	17.5	17.5
	Gross weight	kg	16.5	23.5	23.5
Pipe connections	Water inlet/outlet pipe	inch	G1/2	G1/2	G1/2
	Drain pipe	mm	OD∅25	OD∅25	OD∅25

Notes:

1. H: High fan speed; M: Medium fan speed; L: Low fan speed.

2. Cooling conditions: Entering water 7°C, leaving water 12°C, Entering air temperature 27°C DB/19°C WB.
Heating conditions: Entering water 45°C, leaving water 40°C, Entering air temperature 20°C DB/15°C WB.

3. Noise is tested in semi-anechoic test room.

Four-way Cassette

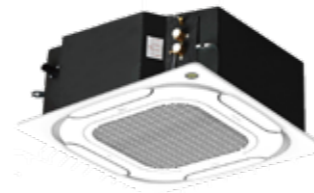
Model: 600/750/850/950/
1200/1500 CFMKJR-29B
Wired controllerCCM30
Central controllerModel(New): 600/700/800/
1000/1200 CFMWDC3-865
Wired controllerR05
Remote controllerRM12F1
Remote controller

Notes: For New Four-way Cassette

Features

- 4-way air supply panel as standard, new 360° air supply panel is optional.
- Built-in PCB and drain pump with pump head-750mm.
- Remote controller with LED display is standard, wired controller is optional.
- Safety grill for safety maintenance.
- Optional extended drainage pan for protecting your ceiling better.
- Compatible with 0-10V input function(customized).
- Available for 2/4 pipe system.

360° airflow for immediate, equal distribution of wider-angle cooling and heating, ideal for standard ceilings.



Stylish Panel with Large Airflow Outlet

4-way air supply panel is standard for 4-way cassette.
360° air supply panel is standard for compact 4-way cassette.



NEW 360° panel

New design, round air flow path ensures uniform air flow and temperature distribution.



Individual louver control

The Individual louver control can control the motors separately, making it possible to control all four louvers independently.



Auto restart

In the event of a sudden power failure during operation, unit restarts automatically and the unit will operate based on the previous setting (operating mode, temperature setting and fan speed).

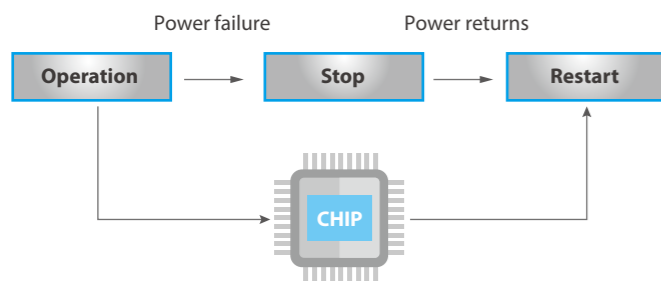

Various Selections

Versions for normal size.
The height of models 600 to 750 is just 230mm whilst models 850 to 1500 is 300mm, making the Four-way Cassette ideal for standard ceilings.

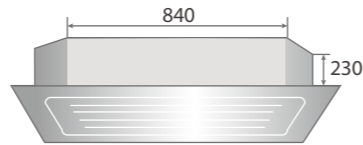

High-lift Drain Pump

A drain pump with a 750mm pump head is fitted as standard, simplifying installation of the drain piping.

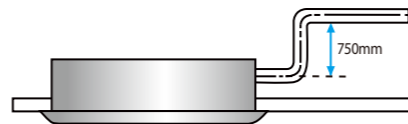

Control solutions

The fan coil units can be connected to Midea central controllers through the customized XYE port, also can be connected to Modbus gateway through the customized PQE port with Modbus RTU protocol.



2-Pipe 4-Way Cassette

Model			MKA-V600R	MKA-V750R	MKA-V850R
Power supply		V/Ph/Hz		220-240/1/50	
Air flow (H/M/L)		m³/h	1175/987/768	1229/1020/810	1451/1146/1012
		CFM	691/580/451	722/600/476	853/674/595
Cooling ¹	Capacity (H/M/L)	kW	5.93/5.3/4.4	6.12/5.45/4.6	7.52/6.46/5.89
	Water flow rate (H/M/L)	m³/h	1.06/0.92/0.77	1.10/0.96/0.81	1.37/1.18/1.07
	Water pressure drop (H/M/L)	kPa	23.8/19.1/13.6	26.0/21.3/12.4	20.1/15.3/12.6
	Power input (H/M/L)	W	41/30/20	49/31/20	68/37/30
Heating ²	Capacity (H/M/L)	kW	6.06/5.72/5.32	6.27/5.88/5.43	7.88/7.48/6.76
	Water flow rate (H/M/L)	m³/h	1.30/1.14/1.13	1.39/1.20/1.00	1.66/1.39/1.25
	Water pressure drop (H/M/L)	kPa	25.9/20.1/19.9	30/22.7/16.3	26.7/18.8/15.6
	Power input (H/M/L)	W	42/28/17	49/32/21	66/37/28
Heating ³	Capacity (H/M/L)	kW	8.42/7.37/6.06	8.62/7.49/6.27	10.37/8.72/7.88
	Water flow rate (H/M/L)	m³/h	1.06/0.92/0.77	1.10/0.96/0.81	1.37/1.18/1.07
	Water pressure drop (H/M/L)	kPa	16.9/12.7/8.6	19.1/14.8/10.6	18.2/13.6/11.1
	Power input (H/M/L)	W	42/28/20	49/31/19	67/37/28
Sound pressure level (H/M/L)		dB(A)	43/39/33	44/40/34	45/40/37
Sound power level (H/M/L)		dB(A)	55/51/45	56/52/46	57/52/49
Fan motor	Type		DC Motor	DC Motor	DC Motor
	Quantity		1	1	1
Fan	Type		Centrifugal, forward-curved Blades		
	Quantity		1	1	1
Coil	Row		2	2	2
	Max. Working pressure	MPa	1.6	1.6	1.6
Panel	Diameter	mm	Ø7	Ø7	Ø7
	Net dimensions (WxHxD)	mm	950x45x950	950x45x950	950x45x950
	Packing size (WxHxD)	mm	1035x90x1035	1035x90x1035	1035x90x1035
	Net weight	kg	6	6	6
	Gross weight	kg	9	9	9
Body	Net dimensions (WxHxD)	mm	840x230x840	840x230x840	840x300x840
	Packing size (WxHxD)	mm	900x237x900	900x237x900	900x330x900
	Net weight	kg	23	23.9	27
	Gross weight	kg	28	28.9	33
Pipe connections	Water inlet/outlet pipe	inch	RC3/4	RC3/4	RC3/4
	Drain pipe	mm	ODØ32	ODØ32	ODØ32

Model			MKA-V950R	MKA-V1200R	MKA-V1500R
Power supply		V/Ph/Hz		220-240/1/50	
Air flow (H/M/L)		m³/h	1530/1224/1101	1581/1371/1236	1871/1415/1198
		CFM	900/720/647	930/806/727	1100/832/704
Cooling ¹	Capacity (H/M/L)	kW	7.84/6.84/6.35	7.87/7.12/6.67	10.70/8.67/7.48
	Water flow rate (H/M/L)	m³/h	1.43/1.24/1.13	1.44/1.28/1.22	1.96/1.53/1.28
	Water pressure drop (H/M/L)	kPa	22/17/14.1	22.3/18.1/16.3	36.6/22.7/16.4
	Power input (H/M/L)	W	75/42/34	85/59/45	137/68/48
Heating ²	Capacity (H/M/L)	kW	8.49/8/7.35	9.16/8.54/7.9	11.86/9.48/8.25
	Water flow rate (H/M/L)	m³/h	1.71/1.45/1.33	1.73/1.57/1.46	2.35/1.86/1.59
	Water pressure drop (H/M/L)	kPa	28.1/20.7/17.4	28.8/24/20.7	49.2/31.2/23.3
	Power input (H/M/L)	W	76/43/33	86/59/45	130/60/41
Heating ³	Capacity (H/M/L)	kW	10.86/9.24/8.49	10.92/9.84/9.16	14.92/10.64/9.13
	Water flow rate (H/M/L)	m³/h	1.43/1.24/1.13	1.44/1.28/1.22	1.96/1.53/1.28
	Water pressure drop (H/M/L)	kPa	19.9/15.2/12.6	20/16.2/14.7	34.3/21.3/15
	Power input (H/M/L)	W	76/42/33	85/58/45	127/58/39
Sound pressure level (H/M/L)		dB(A)	46/42/39	48/44/41	49/43/39
Sound power level (H/M/L)		dB(A)	58/54/51	60/56/53	61/55/51
Fan motor	Type		DC Motor	DC Motor	DC Motor
	Quantity		1	1	1
Fan	Type		Centrifugal, forward-curved Blades		
	Quantity		1	1	1
Coil	Row		2	2	3
	Max. Working pressure	MPa	1.6	1.6	1.6
Panel	Diameter	mm	Ø7	Ø7	Ø7
	Net dimensions (WxHxD)	mm	950x45x950	950x45x950	950x45x950
	Packing size (WxHxD)	mm	1035x90x1035	1035x90x1035	1035x90x1035
	Net weight	kg	6	6	6
	Gross weight	kg	9	9	9
Body	Net dimensions (WxHxD)	mm	840x300x840	840x300x840	840x300x840
	Packing size (WxHxD)	mm	900x330x900	900x330x900	900x330x900
	Net weight	kg	27	27	29.5
	Gross weight	kg	33	33	34.5
Pipe connections	Water inlet/outlet pipe	inch	RC3/4	RC3/4	RC3/4
	Drain pipe	mm	ODØ32	ODØ32	ODØ32

Notes:

H:High fan speed; M: Medium fan speed; L: Low fan speed.

1:Cooling mode (2 and 4-pipe coil): entering air temperature 27°C DB/19°C WB, entering/leaving water temperature 7°C /12°C.

2:Heating mode(1): (2-pipe coil): entering air temperature 20°C DB, entering/leaving water temperature 45/40°C.

3:Heating mode(2): (2-pipe coil): entering air temperature 20°C DB, enter water teperature/water flow 50°C/*(same water flow as in standard rating condition in cooling)

4:Noise is tested in a semi-anechoic test room.

New 2-Pipe 4-Way Cassette

Model		MKA-V600-C	MKA-V700-C	MKA-V800-C
Power supply		220-240/1/50		
Air flow		m³/h 1020/950/880/780/700/620/490	1190/1090/990/900/790/680/560	1360/1280/1180/1040/920/800/650
		CFM 600/558/517/458/411/364/288	700/641/582/529/464/400/329	800/752/694/611/541/470/382
Cooling	Capacity	kW 5.50/5.25/5.00/4.55/4.00/3.20/2.70	6.50/6.10/5.70/5.10/4.80/4.40/3.75	7.50/7.00/6.50/6.00/5.50/4.90/4.30
	Water flow rate	m³/h 1.04/0.97/0.90/0.81/0.71/0.58/0.49	1.20/1.08/0.99/0.90/0.82/0.76/0.70	1.33/1.23/1.13/1.06/0.96/0.85/0.77
	Water pressure drop	kPa 45/35/32/30/25/20/18	30/28/25/20/18/16/14	35/32/29/25/20/18/14
	Power input	W 40/35/30/25/20/15/12	45/35/30/25/20/15/12	60/50/40/30/25/20/15
Heating	Capacity	kW 6.50/6.20/5.90/5.25/4.85/4.30/3.55	7.50/7.20/6.60/6.10/5.50/5.00/4.10	8.50/7.90/7.20/6.60/5.90/5.40/4.70
	Water flow rate	m³/h 1.18/1.09/1.04/0.94/0.84/0.75/0.64	1.35/1.28/1.19/1.07/0.97/0.88/0.81	1.48/1.39/1.28/1.17/1.03/0.93/0.83
	Water pressure drop	kPa 45/35/32/30/25/20/18	30/28/25/20/18/16/14	35/32/29/25/20/18/14
	Power input	W 40/35/30/25/20/15/12	45/35/30/25/20/15/12	60/50/40/30/25/20/15
Sound pressure level	dB(A) 39.8/37.5/35.2/32.3/29.2/25.9/22.3	37.4/34.6/31.8/28.9/25.9/23.5/20.7	41.4/38.7/35.8/32.5/29.1/25.9/23.1	
Sound power level	dB(A) 51.5/49.1/46.5/43.6/40.4/36.9/33.6	50.9/48.4/45.6/42.8/39.9/39.1/36.7	52.7/50.2/47.4/44.5/41.2/37.4/35.35	
Rated current	A	0.4/0.4/0.3/0.3/0.3/0.3		
Fan motor	Type	DC motor		
	Number	1		
Fan	Type	Centrifugal, forward-curved Blades		
	Number	1		
Coil	Row	2		
	Max. Working pressure	MPa 1.6		
	Diameter	mm 7		
Panel	Net dimensions (WxHxD)	950*77*950	950*77*950	950*77*950
	Packing size (WxHxD)	1020*90*1020	1020*90*1020	1020*90*1020
	Net weight	kg 5.8	5.8	5.8
	Gross weight	kg 7.6	7.6	7.6
Body	Net dimensions (WxHxD)	840*204*840	840*288*840	840*335*840
	Packing size (WxHxD)	940*250*940	940*335*940	940*335*940
	Net weight	kg 19.3	23.6	23.6
	Gross weight	kg 22.3	26.2	26.2
Pipe connections	Water inlet/outlet pipe	mm RC3/4		
	Drain pipe	mm Ø25		

Model		MKA-V1000-C	MKA-V1200-C
Power supply		220-240/1/50	
Air flow		m³/h 1700/1600/1450/1250/1150/1000/810	1950/1850/1650/1450/1300/1150/950
		CFM 1000/941/852/735/676/588/476	1147/1088/970/852/764/676/558
Cooling	Capacity	kW 8.50/8.20/7.65/6.95/6.40/5.80/4.85	10.50/10.00/9.50/8.90/8.00/7.10/6.20
	Water flow rate	m³/h 1.56/1.46/1.35/1.22/1.12/1.01/0.86	2.02/1.89/1.76/1.64/1.50/1.32/1.16
	Water pressure drop	kPa 45/40/35/30/25/20/18	45/40/35/30/25/20/17
	Power input	W 100/80/60/50/40/30/20	200/150/110/80/60/40/30
Heating	Capacity	kW 9.50/9.35/8.75/8.10/7.40/6.60/5.80	12.00/11.20/10.50/9.95/9.00/8.00/6.90
	Water flow rate	m³/h 1.73/1.66/1.57/1.44/1.30/1.16/1.02	2.23/2.08/1.89/1.72/1.56/1.38/1.20
	Water pressure drop	kPa 45/40/35/30/25/20/18	45/40/35/30/25/20/17
	Power input	W 100/80/60/50/40/30/20	200/150/110/80/60/40/30
Sound pressure level	dB(A) 46.8/44.5/41.6/38.4/34.8/30.8/26.8	51.5/49.3/46.9/44.2/40.7/36.7/32.0	
Sound power level	dB(A) 59.1/56.8/54.1/51.1/47.7/43.9/40.3	63.5/61.2/58.6/55.7/52.4/48.5/44.1	
Rated current	A	0.8/0.7/0.5/0.4/0.3/0.3/0.3	
Fan motor	Type	DC motor	
	Number	1	
Fan	Type	Centrifugal, forward-curved Blades	
	Number	1	
Coil	Row	2	3
	Max. Working pressure	MPa 1.6	
	Diameter	mm 7	
Panel	Net dimensions (WxHxD)	950*77*950	950*77*950
	Packing size (WxHxD)	1020*90*1020	1020*90*1020
	Net weight	kg 5.8	5.8
	Gross weight	kg 7.6	7.6
Body	Net dimensions (WxHxD)	840*288*840	840*288*840
	Packing size (WxHxD)	940*335*940	940*335*940
	Net weight	kg 23.6	25.9
	Gross weight	kg 26.2	28.3
Pipe connections	Water inlet/outlet pipe	mm RC3/4	
	Drain pipe	mm Ø25	

Notes:

- Cooling mode: entering air temperature 27°C DB/19°C WB, entering/leaving water temperature 7°C /12°C.
- Heating mode: entering air temperature 20°C DB, entering/leaving water temperature 45/40°C.
- Sound power levels are measured 1m around the unit in a semi-anechoic chamber. During in-situ operation. Sound pressure levels are measured 1m below and right of the unit in a semi-anechoic chamber.

4-Pipe 4-Way Cassette

Model		MKA-V600FA	MKA-V750FA	MKA-V850FA
Power supply		220-240/1/50		
Air flow (H/M/L)		m³/h 1184/997/783	1278/1057/855	1328/1052/927
		CFM 696/586/461	752/622/503	781/619/545
Cooling ¹	Capacity (H/M/L)	kW 4.952/4.380/3.640	5.178/4.560/3.880	5.129/4.410/4.060
	Water flow rate (H/M/L)	m³/h 0.9/0.8/0.67	0.94/0.83/0.71	0.93/0.81/0.75
	Water pressure drop (H/M/L)	kPa 14.8/11.5/8.1	15.9/12.4/9	16/14.2/10.4
	Power input (H/M/L)	W 62/44/30	72/50/35	80/49/40
Heating ²	Capacity (H/M/L)	kW 6.148/5.430/4.610	6.519/5.790/4.940	6.684/5.750/5.280
	Water flow rate (H/M/L)	m³/h 0.58/0.52/0.45	0.61/0.55/0.47	0.62/0.54/0.50
	Water pressure drop (H/M/L)	kPa 25.3/20.5/14.5	32/25.7/19.1	32.6/24.7/21.2
	Power input (H/M/L)	W 56/36/21	67/42/25	75/41/31
Heating ³	Capacity (H/M/L)	kW 7.13/6.22/5.27	7.56/6.53/5.60	7.75/6.58/6.03
	Water flow rate (H/M/L)	m³/h 0.64/0.58/0.50	0.68/0.61/0.53	0.71/0.61/0.57
	Water pressure drop (H/M/L)	kPa 36.7/29.7/21.0	46.4/37.3/27.7	47.27/35.82/30.74
	Power input (H/M/L)	W 55/36/21	68/43/25	76/42/31
Sound pressure level (H/M/L)	dB(A) 42/37/31	44/39/33	45/39/36	
Sound power level (H/M/L)	dB(A) 54/49/43	56/51/45	57/51/48	
Rated current	A	0.48		
Fan motor	Type	DC motor		
	Quantity	1		
Fan	Type	Centrifugal, forward-curved Blades		
	Quantity	1		
Coil	Row	2		
	Max. working pressure	MPa 1.6		
	Diameter	mm Ø7		
Panel	Net dimensions (WxHxD)	950x45x950	950x45x950	950x45x950
	Packing size (WxHxD)	1035x90x1035	1035x90x1035	1035x90x1035
	Net weight	kg 6	6	6
	Gross weight	kg 9	9	9
Body	Net dimensions (WxHxD)	840x300x840	840x300x840	840x300x840
	Packing size (WxHxD)	900x330x900	900x330x900	900x330x900
	Net weight	kg 27.5	27.5	27.5
	Gross weight	kg 33.5	33.5	33.5
Pipe connections	Water inlet/outlet pipe	inch Cold water: RC3/4; Hot water: RC1/2		
	Drain pipe	mm ODØ32		

Model		MKA-V950FA	MKA-V1200FA	MKA-V1500FA
Power supply		220-240/1/50		
Air flow (H/M/L)		m³/h 1403/1115/1001	1642/1421/1285	1708/1297/1096
		CFM 825/656/589	966/836/756	1005/763/645
Cooling ¹	Capacity (H/M/L)	kW 5.306/4.590/4.280	7.984/7.250/6.700	8.038/6.620/5.840
	Water flow rate (H/M/L)	m³/h 0.96/0.84/0.78	1.42/1.29/1.2	1.43/1.19/1.05
	Water pressure drop (H/M/L)	kPa 16.4/12.6/10.9	33.9/30/24	33/22.6/17.7
	Power input (H/M/L)	W 90/54/43	121/83/66	139/70/49
Heating ²	Capacity (H/M/L)	kW 6.736/5.830/5.440	9.746/8.960/8.420	9.930/8.330/7.510
	Water flow rate (H/M/L)	m³/h 0.63/0.55/0.52	0.89/0.82/0.77	0.90/0.76/0.69
	Water pressure drop (H/M/L)	kPa 34/26.6/23.5	42.4/36.6/32.6	48.7/32.5/27
	Power input (H/M/L)	W 84/46/35	118/79/61	125/64/42
Heating ³	Capacity (H/M/L)	kW 7.82/6.65/6.20	11.31/11.40/8.53	11.52/9.60/8.68
	Water flow rate (H/M/L)	m³/h 0.71/0.62/0.58	1.0/0.92/0.87	1.02/0.87/0.79
	Water pressure drop (H/M/L)	kPa 49.3/38.6/34.8	61.5/43.1/47.3	70.6/47.1/39.2
	Power input (H/M/L)	W 84/45/35	118/79/61	125/64/42
Sound pressure level (H/M/L)	dB(A) 46/41/38	48/44/42	49/43/38	
Sound power level (H/M/L)	dB(A) 58/53/50	60/56/54	61/55/50	
Rated current	A	0.72		
Fan motor	Type	DC motor		
	Quantity	1		
Fan	Type	Centrifugal, forward-curved Blades		
	Quantity	1		
Coil	Row	2		
	Max. working pressure	MPa 1.6		
	Diameter	mm Ø7		
Panel	Net dimensions (WxHxD)	950x45x950	950x45x950	950x45x950
	Packing size (WxHxD)	1035x90x1035	1035x90x1035	1035x90x1035
	Net weight	kg 6	6	6
	Gross weight	kg 9	9	9
Body	Net dimensions (WxHxD)	840x300x840	840x300x840	840x300x840
	Packing size (WxHxD)	900x330x900	900x330x900	900x330x900
	Net weight	kg 27.5	30	30
	Gross weight	kg 32.4	35	35
Pipe connections	Water inlet/outlet pipe	inch Cold water: RC3/4; Hot water: RC1/2		
	Drain pipe	mm ODØ32		

Notes:

- H: High fan speed; M: Medium fan speed; L: Low fan speed.
- 1: Cooling mode (2 and 4-pipe coil): entering air temperature 27°C DB/19°C WB, entering/leaving water temperature 7°C /12°C.
- 2: Heating mode(1): (4-pipe coil): entering air temperature 20°C DB, entering/leaving water temperature 65/55°C.
- 3: Heating mode(2): (4-pipe coil): entering air temperature 20°C DB, entering/leaving water temperature 70/60°C.
- 4: Sound pressure level is tested in a semi-anechoic test room.
- 5: Sound power level is tested in a reverberation chamber test room.

New 4-Pipe 4-Way Cassette

Model		MKA-V600F-C	MKA-V700F-C	MKA-V800F-C
Power supply		V/Ph/Hz		
Air flow		220-240/1/50		
		m³/h	1020/930/870/800/720/620/520	1190/1080/950/880/790/680/560
		CFM	600/547/511/470/423/364/305	700/635/558/517/464/400/329
Cooling	Capacity	kW	4.70/4.40/4.00/3.70/3.40/3.00/2.65	5.00/4.70/4.40/4.15/3.90/3.55/3.00
	Water flow rate	m³/h	0.88/0.82/0.74/0.65/0.60/0.53/0.46	0.90/0.88/0.83/0.77/0.74/0.67/0.63
	Water pressure drop	kPa	30/28/26/25/22/16/14	35/32/30/27/25/20/15
	Power input	W	40/30/25/20/15/12/10	45/35/30/25/20/15/13
Heating	Capacity	kW	7.30/6.90/6.40/6.00/5.30/4.40/3.80	7.00/7.00/6.70/6.40/6.30/5.50/4.65
	Water flow rate	m³/h	0.68/0.63/0.59/0.55/0.50/0.41/0.33	0.71/0.68/0.64/0.61/0.57/0.51/0.41
	Water pressure drop	kPa	30/28/26/25/22/16/14	35/32/30/27/25/20/15
	Power input	W	40/30/25/20/15/12/10	45/35/30/25/20/15/13
Sound pressure level	dB(A)	34.2/31.5/29.0/26.3/24.1/21.8/20.6	37.4/34.5/31.6/28.4/25.6/23.2/21.0	41.2/38.6/35.7/32.2/28.9/25.6/22.8
Sound power level	dB(A)	46.8/44.1/41.4/38.4/35.4/32.4/30.3	49.7/47.1/44.2/41.2/37.9/35.0/31.8	53.5/50.9/48.0/44.9/41.6/38.0/35.1
Rated current	A	0.4/0.4/0.3/0.3/0.3/0.3		
Fan motor	Type	DC motor		
	Number	1		
Fan	Type	Centrifugal, forward-curved Blades		
	Number	1		
Coil	Row	2		
	Max. Working pressure	MPa	1.6	
	Diameter	mm	7	
Panel	Net dimensions (WxHxD)	mm	950*77*950	950*77*950
	Packing size (WxHxD)	mm	1020*90*1020	1020*90*1020
	Net weight	kg	5.8	5.8
	Gross weight	kg	7.6	7.6
Body	Net dimensions (WxHxD)	mm	840*288*840	840*288*840
	Packing size (WxHxD)	mm	940*335*940	940*335*940
	Net weight	kg	23.9	23.9
	Gross weight	kg	26.4	26.4
Pipe connections	Water inlet/outlet pipe	mm	RC3/4-RC1/2	
	Drain pipe	mm	Φ25	

Model		MKA-V1000F-C	MKA-V1200F-C	
Power supply		220-240/1/50		
Air flow		2042/1507/966		
		m³/h	1703/1259/807	
		CFM	1000/741/475	
Cooling	Capacity	kW	9.01/7.16/5.12	
	Water flow rate	m³/h	1.6/1.25/0.89	
	Water pressure drop	kPa	38.95/24.65/13.18	
	Power input	W	110/48/19	
Heating	Capacity	kW	9.42/7.88/6.04	
	Water flow rate	m³/h	0.82/0.7/0.53	
	Water pressure drop	kPa	43.59/32.29/19.22	
	Power input	W	109/47/18	
Sound pressure level	dB(A)	46.9/38.8/27.5	51.3/43.6/31.8	
Sound power level	dB(A)	60.1/52.2/41.2	64.4/56.7/45.8	
Rated current	A	1/0.5/0.3		
Fan motor	Type	DC motor		
	Number	1		
Fan	Type	Centrifugal, forward-curved Blades		
	Number	1		
Coil	Row	3		
	Max. Working pressure	MPa	1.6	
	Diameter	mm	7	
Panel	Net dimensions (WxHxD)	mm	950*77*950	
	Packing size (WxHxD)	mm	1020*90*1020	
	Net weight	kg	5.8	
	Gross weight	kg	7.6	
Body	Net dimensions (WxHxD)	mm	840*288*840	
	Packing size (WxHxD)	mm	940*335*940	
	Net weight	kg	26.2	
	Gross weight	kg	28.6	
Pipe connections	Water inlet/outlet pipe	mm	RC3/4-RC1/2	
	Drain pipe	mm	Φ25	

Notes:

- Cooling mode: entering air temperature 27°C DB/19°C WB, entering/leaving water temperature 7°C/12°C.
- Heating mode: entering air temperature 20°C DB, entering/leaving water temperature 65/55°C.
- Sound power levels are measured 1m around the unit in a semi-anechoic chamber. During in-situ operation. Sound pressure levels are measured 1m below and right of the unit in a semi-anechoic chamber.

Compact Four-way Cassette



Model: 300/400/500 CFM

R05
StandardKJR-29B
Optional

Features

- 360° air supply panel is standard.
- Built-in PCB and drain pump with pump head-500mm.
- Remote controller with LED display is standard, wired controller is optional.
- Safety grill for safety maintenance.
- Optional extended drainage pan for protecting your ceiling better.
- Available for 2/4 pipe system.

Compact design allows installation in shallow ceilings.



360° Airflow

The 360° air outlets of Compact Four-way Cassette provide strong airflow circulation to cool or heat every corner of a room and evenly control temperature.

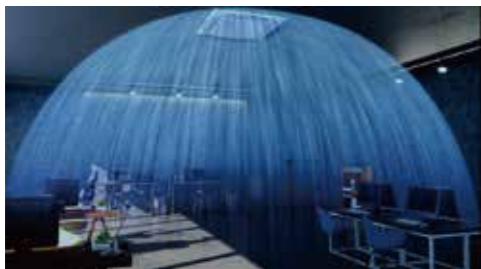

Multiple Fan Speeds

The DC Series comes with 3 fan speed option to meet the needs of different indoor conditions.

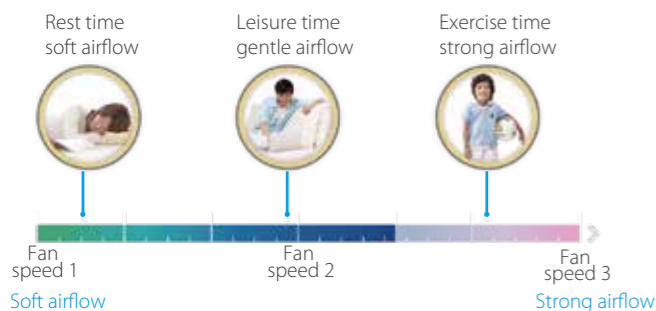

High-lift Drain Pump

A drain pump with a 500mm pump head is fitted as standard, simplifying installation of the drain piping.

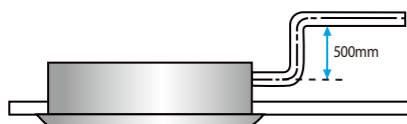

Auto restart

In the event of a sudden power failure during operation, unit restarts automatically and the unit will operate based on the previous setting (operating mode, temperature setting and fan speed).

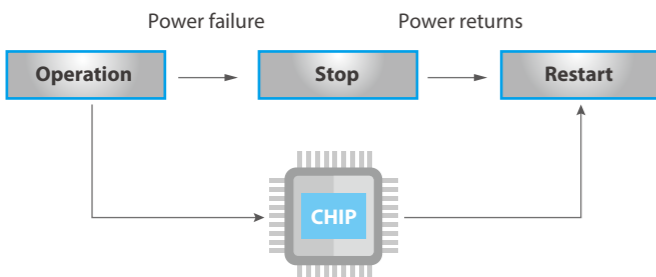

Control solutions

The fan coil units can be connected to Midea central controllers through the customized XYE port, also can be connected to Modbus gateway through the customized PQE port with Modbus RTU protocol.

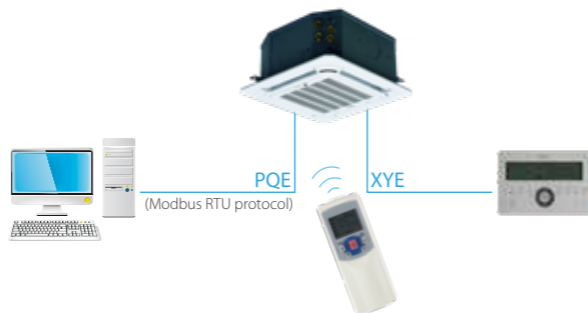

Compact design

The height of models 300 to 500 is just 261mm, making the Compact Four-way Cassette ideal for standard ceilings.



Compact Four-way Cassette body dimension is only 575 mm x 575 mm which can easily fits into less than 585 mm ceiling grid.

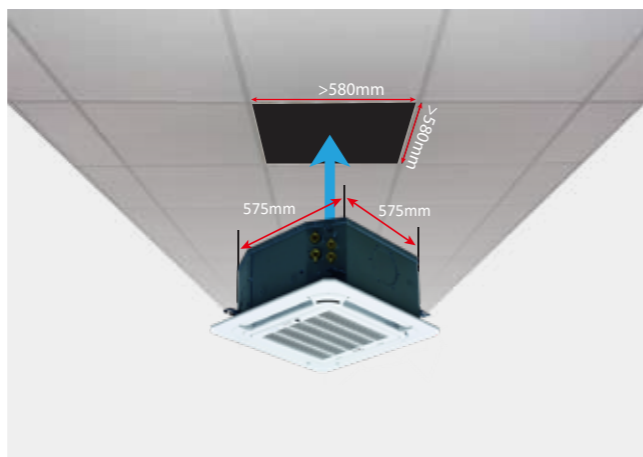

2-Pipe Compact 4-Way Cassette

Model			MKD-V300	MKD-V400	MKD-V500
Power supply		V/Ph/Hz	220-240/1/50		
Air flow (H/M/L)		m³/h	535/429/322	719/477/381	781/611/494
		CFM	315/252/189	423/281/224	459/359/290
Cooling ¹	Capacity (H/M/L)	kW	2.98/2.53/2	3.96/3.26/2.76	4.23/4.48/3.01
	Water flow rate(H/M/L)	m³/h	0.53/0.45/0.35	0.7/0.58/0.51	0.75/0.61/0.54
	Water pressure drop(H/M/L)	kPa	10/7/5	11.50/8.20/6.50	12.30/8.60/7.40
	Power input(H/M/L)	W	22.7/9/5	37/15/9	43/28/21
Heating ²	Capacity (H/M/L)	kW	2.61/2.31/2.24	4.08/3.34/2.73	4.95/3.99/3.26
	Water flow rate(H/M/L)	m³/h	0.64/0.54/0.42	0.83/0.67/0.56	0.87/0.70/0.58
	Water pressure drop(H/M/L)	kPa	12.1/8.5/5.3	12.68/8.6/6	9.4/8.23/6.1
	Power input(H/M/L)	W	15/9/5	28/16/10	33/18/11
Heating ³	Capacity (H/M/L)	kW	4.01/3.35/2.61	4.78/3.84/3.16	5.76/4.69/3.84
	Water flow rate(H/M/L)	m³/h	0.53/0.45/0.35	0.7/0.58/0.51	0.75/0.61/0.54
	Water pressure drop(H/M/L)	kPa	8.2/6/3.8	12.68/6.4/4.92	11.41/6.5/5.41
Sound pressure level	(H/M/L)	dB(A)	39/33/27	42/36/30	43/38/32
Sound power level	(H/M/L)	dB(A)	51/45/39	54/48/42	55/50/44
Fan motor	Type		DC Motor		
	Quantity		1		
Fan	Type		Centrifugal, forward-curved Blades		
	Quantity		1		
Coil	Row		2		
	Max. working pressure	MPa	1.6		
	Diameter	mm	Ø7		
Panel	Net dimensions (WxHxD)	mm	647x50x647		
	Packing size (WxHxD)	mm	715x123x715		
	Net weight	kg	2.5		
Body	Gross weight	kg	4.5		
	Net dimensions (WxHxD)	mm	575x261x575		
	Packing size (WxHxD)	mm	675x320x675		
Pipe connections	Water inlet/outlet pipe	inch	G3/4		
	Drain pipe	mm	ODØ25		

4-Pipe Compact 4-Way Cassette

Model			MKD-V300FA	MKD-V400FA	MKD-V500FA
Power supply		V/Ph/Hz	220-240/1/50		
Air flow (H/M/L)		m³/h	493/395/295	669/523/415	673/526/425
		CFM	290/232/173	394/308/244	396/309/250
Cooling ¹	Capacity (H/M/L)	kW	2.161/1.860/1.490	2.777/2.380/2.050	3.100/2.380/2.070
	Water flow rate (H/M/L)	m³/h	0.42/0.37/0.3	0.53/0.46/0.4	0.56/0.49/0.43
	Water pressure drop (H/M/L)	kPa	17.4/13.5/9.3	13.15/9.4/7	16.8/13.1/10.3
	Power input (H/M/L)	W	24/18/14	38/35/30	42/27/20
Heating ²	Capacity (H/M/L)	kW	3.131/2.630/2.080	3.711/3.140/2.650	3.942/3.300/2.830
	Water flow rate (H/M/L)	m³/h	0.32/0.28/0.23	0.37/0.32/0.28	0.42/0.36/0.32
	Water pressure drop (H/M/L)	kPa	23.5/17.1/11.3	24.1/17.9/13.1	26.8/19.2/14.5
	Power input (H/M/L)	W	17/10/6	32/18/11	35/18/11
Heating ³	Capacity (H/M/L)	kW	3.63/2.99/2.36	4.30/3.58/3.02	4.57/3.79/3.22
	Water flow rate (H/M/L)	m³/h	0.36/0.31/0.25	0.41/0.36/0.31	0.47/0.40/0.36
	Water pressure drop (H/M/L)	kPa	34.1/24.8/16.4	34.9/26.0/19.0	38.9/27.8/21.0
Sound pressure level (H/M/L)		dB(A)	39/33/27	42/35/30	44/39/31
Sound power level (H/M/L)		dB(A)	51/45/39	54/47/42	56/51/43
Rated current		A	0.24	0.36	0.48
Fan motor	Type		DC motor		
	Quantity		1		
Fan	Type		Centrifugal, forward-curved Blades		
	Quantity		1		
Coil	Row		2		
	Max. working pressure	MPa	1.6		
	Diameter	mm	Ø7		
Panel	Net dimensions (WxHxD)	mm	647x50x647		
	Packing size (WxHxD)	mm	715x123x715		
	Net weight	kg	2.5		
Body	Gross weight	kg	4.5		
	Net dimensions (WxHxD)	mm	575x261x575		
	Packing size (WxHxD)	mm	675x320x675		
Pipe connections	Water inlet/outlet pipe	inch	Cold water: G3/4; Hot water: G1/2		
	Drain pipe	mm	ODØ25		

Notes:

- H: High fan speed; M: Medium fan speed; L: Low fan speed.
- 1. Cooling mode (2 and 4-pipe coil): entering air temperature 27°C DB/1 9°C WB, entering/leaving water temperature 7°C /12°C.
- 2. Heating mode(1): (2-pipe coil): entering air temperature 20°C DB, entering/leaving water temperature 45/40°C.
- 3. Heating mode(2): (2-pipe coil): entering air temperature 20°C DB, enter water teperature/water flow 50°C/* (same water flow as in standard rating condition in cooling)
- 4. Heating mode(1): (4-pipe coil): entering air temperature 20°C DB, entering/leaving water temperature 65/55°C.
- 5. Heating mode(2): (4-pipe coil): entering air temperature 20°C DB, entering/leaving water temperature 70/60°C.
- 6. Sound pressure level is tested in a semi-anechoic test room.
- 7. Sound power level is tested in a reverberation chamber test room.

Duct series



Model: 200/300/400/500/600/700/800/1000/1200/1400CFM



RM05+FCU KIT
Optional, MK-CBS series don't need FCU KIT



KJRP-86I/MFK-E
KJRP-86I/MFKS-E
KJRP-86A/BMFNKD-E
Optional, only for MKT series



WDC3-86S
Optional, only for MK-CBS series

Features

- 2, 3 or 4 row for 2-pipe system and 3 row MKT series can be customization for 4-pipe system.
- Different static pressures (12/30/50Pa) can be set by dialing the PCB. For MK-CBS series, it can also be set by wired controller.
- Washable filter: Iron frame filter is standard, and aluminum frame filter can be customized.
- Compatible with two types of air return: Back return is standard ,bottom return is optional.
- Left or right hand piping connections are easily change in filed.

Slim, compact design for limited space with duct distribution to the indoor space.



Flexible Installation

Left and right hand piping connections are optional, flexible installation.

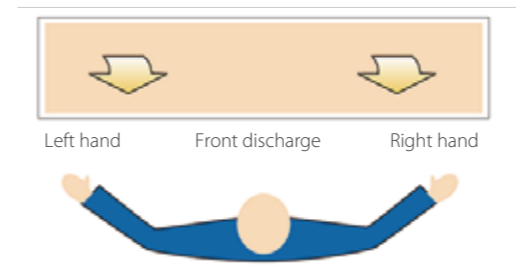

Compact Size

Min. height of 241mm, high, easy for limited space installation.

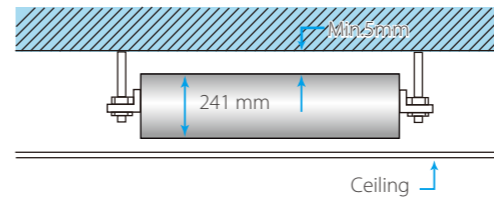

Flexible Air Inlet Port Installation

To provide the flexibility to adapt to differing installation situations, the air inlet may be positioned either on the underside or the rear of the unit.

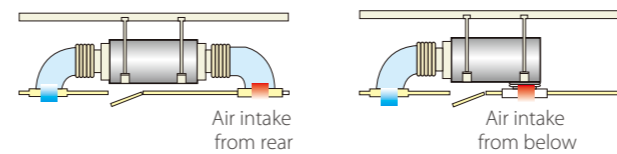

Extension water pan are optional to protect the ceiling from moisture.



Multiple Fan Speeds

7 indoor fan speed options for MK-CBS series and 3 indoor fan speed options for MKT series to meet the needs of different indoor conditions.

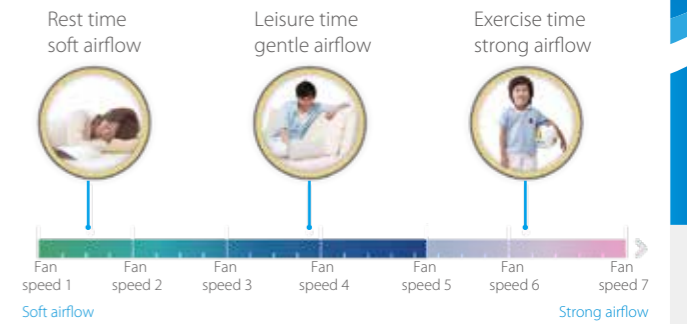

Control solutions

The MKT series duct controlled by Wired controller, Central controller or BMS need to customize FCU KIT.

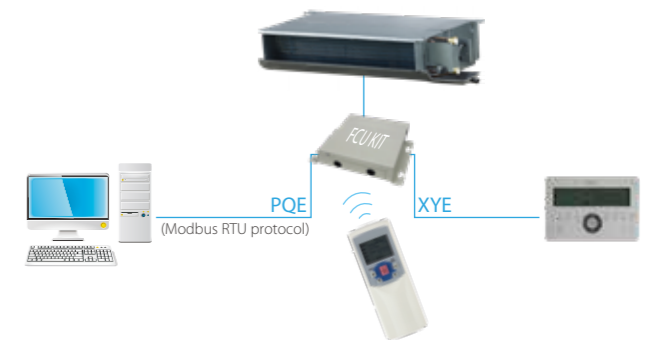

Washable filter

Iron frame filter is standard, and aluminum frame filter can be customized. Air outlet flange and multi-direction pull-out filter can be customized.

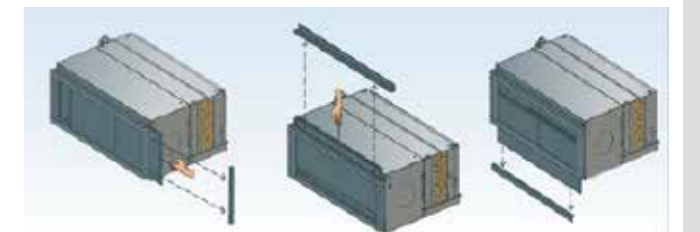

2-Pipe 2-Row Duct

Model		MKT2-V200	MKT2-V300	MKT2-V400	MKT2-V500	
Power supply		220-240/1/50				
Air flow (H/M/L)		V/Ph/Hz				
		m ³ /h	439/295/221	615/439/310	792/622/413	887/620/443
		CFM	258/173/130	361/258/182	465/365/242	521/364/260
Standard external static pressure		Pa	12Pa (default); 30/50Pa can be set through dial switch on PCB			
Cooling ¹	Capacity (H/M/L)	kW	2.02/1.52/1.17	2.82/2.33/1.79	3.31/2.78/2.14	3.83/3.16/2.55
	Water flow rate (H/M/L)	m ³ /h	0.37/0.28/0.22	0.51/0.41/0.32	0.59/0.50/0.38	0.68/0.56/0.46
	Water pressure drop (H/M/L)	kPa	6.3/3.60/2.20	14.20/10.5/7.30	19.40/14.80/9.60	23.7/17.1/11.9
	Power input (H/M/L)	W	18/9/6	25/15/11	29/16/9	42/20/11
Heating ²	Capacity (H/M/L)	kW	2.57/1.89/1.47	3.56/2.8/2.08	4.19/3.42/2.49	4.84/3.9/3.01
	Water flow rate (H/M/L)	m ³ /h	0.47/0.34/0.27	0.62/0.50/0.37	0.72/0.6/0.45	0.84/0.69/0.53
	Water pressure drop (H/M/L)	kPa	5.64/4.5/2.9	10.54/10.3/6.3	16.20/16.6/10	30.8/32.4/20
	Power input (H/M/L)	W	19/9/7	25/15/11	32/17/9	45/22/12
Heating ³	Capacity (H/M/L)	kW	2.98/2.22/1.73	4.12/3.26/2.39	4.91/4.1/3.02	5.6/4.49/3.45
	Water flow rate (H/M/L)	m ³ /h	0.37/0.28/0.22	0.51/0.41/0.32	0.59/0.50/0.38	0.68/0.56/0.46
	Water pressure drop (H/M/L)	kPa	7.90/3.5/2.3	15.40/7.40/4.80	23.00/12.10/7.80	29.00/14.20/9.70
	Power input (H/M/L)	W	19/9/7	25/15/11	31/18/9	45/21/11
Sound pressure level	0Pa (H/M/L)	dB(A)	37.5/27.4/24.0	40.3/33.1/26.7	41.1/34.7/26.8	44.6/36.8/29.4
Sound power level	0Pa (H/M/L)	dB(A)	52/42/33	51/44/35	53/47/39	56/49/42
Fan motor	Type	DC Motor				
	Quantity	1				
Fan	Type	Centrifugal, forward-curved Blades				
	Quantity	1				
	Row	2				
Coil	Max. working pressure	MPa	1.6			
	Diameter	mm	Ø9.52			
	Net dimensions (WxHxD)	mm	741x241x522			
Packing size (WxHxD)	mm	790x260x555				
Net weight	kg	16.5				
Gross weight	kg	19				
Water inlet/outlet pipe	inch	RC3/4				
Drain pipe	inch	R3/4				

Model		MKT2-V600	MKT2-V800	MKT2-V1000	MKT2-V1200	
Power supply		220-240/1/50				
Air flow (H/M/L)		V/Ph/Hz				
		m ³ /h	1081/821/586	1492/1071/797	1824/1332/906	2327/1669/1135
		CFM	635/482/344	877/630/468	1072/783/532	1368/981/667
Standard external static pressure		Pa	12Pa (default); 30/50Pa can be set through dial switch on PCB			
Cooling ¹	Capacity (H/M/L)	kW	4.78/4.01/3.09	6.7/5.49/4.45	7.92/6.62/5.15	9.83/7.7/5.86
	Water flow rate (H/M/L)	m ³ /h	0.85/0.69/0.54	1.19/0.96/0.80	1.43/1.17/0.91	1.74/1.42/1.12
	Water pressure drop (H/M/L)	kPa	14.2/9.8/6.1	15.10/10.90/7.80	23.20/16.40/10.90	50.30/30.40/21.70
	Power input (H/M/L)	W	53/25/12	62/28/16	93/42/19	136/66/30
Heating ²	Capacity (H/M/L)	kW	6.25/5.17/4.03	8.39/6.64/5.2	9.92/7.94/5.86	12.58/9.26/6.85
	Water flow rate (H/M/L)	m ³ /h	1.10/0.91/0.7	1.46/1.17/0.91	1.69/1.38/1.01	2.17/1.79/1.34
	Water pressure drop (H/M/L)	kPa	12.36/14.2/8.9	13.26/13.10/8.30	19.72/18.90/11.10	60.7/46.2/29.3
	Power input (H/M/L)	W	58/27/13	66/30/16	100/44/19	136/66/30
Heating ³	Capacity (H/M/L)	kW	7.19/5.92/4.55	9.87/7.83/6.29	11.63/9.37/6.96	14.58/11.82/8.83
	Water flow rate (H/M/L)	m ³ /h	0.85/0.69/0.54	1.19/0.96/0.80	1.43/1.17/0.91	1.74/1.42/1.12
	Water pressure drop (H/M/L)	kPa	19.90/8.60/5.40	19.40/9.00/6.40	26.70/14.00/9.10	60.7/26.5/17.8
	Power input (H/M/L)	W	58/27/13	66/30/17	99/45/19	119/55/24
Sound pressure level	0Pa (H/M/L)	dB(A)	46.1/38.9/29.9	47.7/39.4/31.1	50.2/43.0/33.0	50.9/44.0/33.8
Sound power level	0Pa (H/M/L)	dB(A)	58/51/42	59/51/43	62/55/45	63/56/47
Fan motor	Type	DC Motor				
	Quantity	2				
Fan	Type	Centrifugal, forward-curved Blades				
	Quantity	2				
	Row	2				
Coil	Max. working pressure	MPa	1.6			
	Diameter	mm	Ø9.52			
	Net dimensions (WxHxD)	mm	1161x241x522			
Packing size (WxHxD)	mm	1210x260x560				
Net weight	kg	22.2				
Gross weight	kg	26				
Water inlet/outlet pipe	inch	RC3/4				
Drain pipe	inch	R3/4				

Notes:

1. H: High fan speed; M: Medium fan speed; L: Low fan speed;
2. Cooling conditions : water inlet 7°C, water outlet 12°C, entering air temperature 27°C DB/19°C WB, with air return plenum and filter;
3. Heating conditions : water inlet 45°C, water outlet 40°C, entering air temperature 20°C DB, with air return plenum and filter;
4. Sound pressure level is tested in the semi-anechoic room with background noise is 17.5dB (A), when the unit is without accessories and running in dry condition, at 1m below & 1m front the vertical center line of the unit with 1m outlet duct;
5. Air flow is tested under dry condition, 20 °C DB, with air return plenum and filter;
6. Left and right unit can be changed in the field, but cooling should be multiplied with correction factor 0.9;
7. The performance data on above sheet was tested under 220V~50Hz;
8. Auxiliary electric heater (AEH) is optional;
9. All specifications are subject to change by the manufacturer without prior notice.

2-Pipe 3-Row Duct

Model		MKT3-V200	MKT3-V300	MKT3-V400	MKT3-V500	
Power supply		220-240/1/50				
Air flow (H/M/L)		V/Ph/Hz				
		m ³ /h	411/273/171	596/442/311	734/564/389	865/626/441
		CFM	241/160/100	351/260/182	431/331/228	508/368/259
Standard external static pressure		Pa	12Pa (default); 30/50Pa can be set through dial switch on PCB			
Cooling ¹	Capacity (H/M/L)	kW	2.35/1.72/1.32	3.12/2.72/2.1	3.99/3.26/2.5	4.46/3.59/2.83
	Water flow rate (H/M/L)	m ³ /h	0.43/0.31/0.25	0.6/0.48/0.37	0.69/0.57/0.43	0.79/0.63/0.50
	Water pressure drop (H/M/L)	kPa	13.6/8.6/6.3	23.8/16.4/11.3	13/9.3/5.8	16.4/11.3/7.6
	Power input (H/M/L)	W	17/9/7	23/15/10	26/15/9	39/19/11
Heating ²	Capacity (H/M/L)	kW	2.68/1.99/1.42	3.82/3.08/2.28	4.7/3.85/2.77	5.27/4.21/3.21
	Water flow rate (H/M/L)	m ³ /h	0.49/0.35/0.26	0.67/0.54/0.41	0.82/0.67/0.50	0.92/0.73/0.57
	Water pressure drop (H/M/L)	kPa	12.6/7.6/4.9	25/17.6/11.3	13/10.5/6.2	18.4/12.4/8.1
	Power input (H/M/L)	W	18/9/7	23/15/10	26/16/9	43/21/11
Heating ³	Capacity (H/M/L)	kW	3.17/2.27/1.75	4.51/3.61/2.71	5.52/4.55/3.27	6.26/4.99/3.81
	Water flow rate (H/M/L)	m ³ /h	0.43/0.31/0.25	0.60/0.48/0.37	0.69/0.57/0.43	0.79/0.63/0.50
	Water pressure drop (H/M/L)	kPa	10.3/6.1/4.2	19.2/12.9/8.5	10.8/7.7/4.8	13.7/9.5/6.3
	Power input (H/M/L)	W	18/9/7	23/15/10	28/16/9	43/21/11
Sound pressure level	0Pa (H/M/L)	dB(A)	38.1/28.4/23.4	36.4/29.5/20.7	38.4/32.2/24.0	44.3/36.3/27.9
Sound power level	0Pa (H/M/L)	dB(A)	50/40/33	50/44/37	52/45/38	56/48/41
Fan motor	Type	DC Motor				
	Quantity	1				
Fan	Type	Centrifugal, forward-curved Blades				
	Quantity	1				
	Row	3				
Coil	Max. working pressure	MPa	1.6			
	Diameter	mm	Ø9.52			
	Net dimensions (WxHxD)	mm	741x241x522			
Packing size (WxHxD)	mm	790x260x555				
Net weight	kg	16.7				
Gross weight	kg	19.7				
Water inlet/outlet pipe	inch	RC3/4				
Drain pipe	inch	R3/4				

Model		MKT3-V600	MKT3-V800	MKT3-V1000	MKT3-V1200	
Power supply		220-240/1/50				
Air flow (H/M/L)		V/Ph/Hz				
		m ³ /h	1022/760/544	1452/1038/781	1824/1332/906	2134/1581/1083
		CFM	601/447/320	854/610/459	1072/783/532	1255/930/637
Standard external static pressure		Pa	12Pa (default); 30/50Pa can be set through dial switch on PCB			
Cooling ¹	Capacity (H/M/L)	kW	5.85/4.82/3.78	8.02/6.36/5.08	8.96/7.37/5.66	10.79/8.86/6.79
	Water flow rate (H/M/L)	m ³ /h	1.05/0.85/0.65	1.42/1.11/0.89	1.59/1.29/0.98	1.93/1.57/1.20
	Water pressure drop (H/M/L)	kPa	31.4/22/14.2	31.6/20.5/13.9	24.1/16.9/10.8	26.3/18.8/12.8
	Power input (H/M/L)	W	49/24/12	60/28/16	96/43/19	106/49/24
Heating ²	Capacity (H/M/L)	kW	6.62/5.38/4	9.15/7.08/5.58	10.74/8.55/6.35	12.62/10.15/7.47
	Water flow rate (H/M/L)	m ³ /h	1.15/0.94/0.71	1.59/1.26/0.98	1.88/1.51/1.13	2.23/1.78/1.31
	Water pressure drop (H/M/L)	kPa	31.7/22.2/13.6	32.9/21.6/13.9	28.3/19.4/12	29.4/20/11.9
	Power input (H/M/L)	W	53/26/12	65/30/17	100/45/20	115/52/22
Heating ³	Capacity (H/M/L)	kW	7.84/6.35/4.81	10.88/8.46/6.68	12.61/10.04/7.35	14.9/11.92/8.89
	Water flow rate (H/M/L)	m ³ /h	1.05/0.85/0.65	1.42/1.11/0.89	1.59/1.29/0.98	1.93/1.57/1.20
	Water pressure drop (H/M/L)	kPa	26.4/18.2/11.4	26.3/16.9/11.5	21.1/14.8/9.5	22.6/16/10.2
	Power input (H/M/L)	W	52/25/13	65/30/17	99/44/19	114/51/22
Sound pressure level	0Pa (H/M/L)	dB(A)	46.1/39.0/30.3	44.9/36.1/27.7	47.8/40.7/30.7	48.9/41.8/31.7
Sound power level	0Pa (H/M/L)	dB(A)	57/49/42	58/49/42	62/54/45	62/54/45
Fan motor	Type	DC Motor				
	Quantity	2				
Fan	Type	Centrifugal, forward-curved Blades				
	Quantity	2				
	Row	3				
Coil	Max. working pressure	MPa	1.6			
	Diameter	mm	Ø9.52			
	Net dimensions (WxHxD)	mm	1161x241x522			
Packing size (WxHxD)	mm	1210x260x560				
Net weight	kg	23.7				
Gross weight	kg	27.2				
Water inlet/outlet pipe	inch	RC3/4				
Drain pipe	inch	R3/4				

Notes:

1. H: High fan speed; M: Medium fan speed; L: Low fan speed;
2. Cooling conditions : water inlet 7°C, water outlet 12°C, entering air temperature 27°C DB/19°C WB, with air return plenum and filter;
3. Heating conditions : water inlet 45°C, water outlet 40°C, entering air temperature 20°C DB, with air return plenum and filter;
4. Sound pressure level is tested in the semi-anechoic room with background noise is 17.5dB (A), when the unit is without accessories and running in dry condition, at 1m below & 1m front the vertical center line of the unit with 1m outlet duct;
5. Air flow is tested under dry condition, 20 °C DB, with air return plenum and filter;
6. Left and right unit can be changed in the field, but cooling should be multiplied with correction factor 0.9;
7. The performance data on above sheet was tested under 220V~50Hz;
8. Auxiliary electric heater (AEH) is optional;
9. All specifications are subject to change by the manufacturer without prior notice.

New DC 2-pipe 3-row FCU (MKT3-C)

Model		MKT3-V200G12-CL	MKT3-V300G12-CL	MKT3-V400G12-CL	MKT3-V500G12-CL	MKT3-V600G12-CL	
Power supply	V/Ph/Hz	220-240V/1/50					
Air flow	m³/h	374/301/228	550/421/307	734/584/436	800/622/456	1022/810/552	
	CFM	220/177/134	324/248/181	432/344/256	471/366/268	601/476/325	
Standard external static pressure	Pa	12Pa (default); 30/50Pa a can be set through dial switch on the PCB or by wired controller					
Cooling	Capacity (H/M/L)	kW	2.45/2.05/1.59	3.35/2.89/2.21	4.25/3.69/2.88	4.55/3.92/2.97	5.85/4.88/3.66
	Water pressure drop (H/M/L)	kPa	17.0/13.7/10.94	23.0/17.6/10.6	19.0/14.7/9.4	23.00/18.96/12.11	34.0/26.5/16.9
	Water flow rate (H/M/L)	m³/h	0.41/0.35/0.28	0.59/0.49/0.37	0.76/0.63/0.49	0.80/0.67/0.54	1.00/0.84/0.65
Heating	Capacity (H/M/L)	kW	2.68/2.24/1.83	3.95/3.25/2.51	5.00/4.31/3.36	5.50/4.38/3.20	6.90/5.66/4.21
	Water pressure drop (H/M/L)	kPa	17.00/13.10/11.86	25.0/18.1/11.2	21.0/15.9/9.9	25.00/19.93/11.95	38.0/28.7/18.6
	Water flow rate (H/M/L)	m³/h	0.45/0.38/0.33	0.67/0.55/0.42	0.89/0.74/0.57	0.92/0.76/0.59	1.16/0.96/0.75
Power input (H/M/L)	W	17.0/12.0/9.0	23.0/15.0/10.0	34.0/22.0/13.0	37.0/26.0/14.0	64.0/36.0/19.0	
Auxiliary electric heater (AEH)	W	500	600	1000	1000	1500	
Sound pressure level	dB(A)	39/33/25	37/31/22.5	43/37.5/30	45/39/31	49.5/43.5/34	
Fan motor	Type	/	DC motor				
	Quantity	/	1				
Fan	Type	/	Centrifugal, forward-curved blades				
	Quantity	/	1	2	2	2	2
Coil	Row	/	3				
	Max. working pressure	MPa	1.6MPa				
	Diameter	mm	7				
Net dimensions (WxHxD)	mm	632x243x482	773x243x482	908x243x482	908x243x482	1003x243x482	
Packing size (WxHxD)	mm	698x270x520	843x270x520	978x270x520	978x270x520	1073x270x520	
Net weight	kg	14	17.2	19.2	19.2	21.7	
Gross weight	kg	16	19.5	22.2	22.2	24.5	
Water inlet/outlet pipe	inch	RC3/4					
Drain pipe	inch	ZG3/4					

Notes:

1. H: High fan speed; M: Medium fan speed; L: Low fan speed;
2. Cooling conditions : water inlet 7°C, water outlet 12°C, entering air temperature 27°C DB/19°C WB, with air return plenum and filter;
3. Heating conditions : water inlet 45°C, water outlet 40°C, entering air temperature 20°C DB, with air return plenum and filter;
4. Sound pressure level is tested in the semi-anechoic room with background noise is 17.5dB (A), when the unit is without accessories and running in dry condition, at 1m below & 1m front the vertical center line of the unit with 1m outlet duct;
5. Air flow is tested under dry condition, 20 C DB, with air return plenum and filter;
6. Left and right unit can be changed in the field, but cooling should be multiplied with correction factor 0.9;
7. The performance data on above sheet was tested under 220V~50Hz;
8. Auxiliary electric heater (AEH) is optional;
9. All specifications are subject to change by the manufacturer without prior notice.

New DC 2-pipe 3-row FCU (MKT3-C)

Model		MKT3-V700G12-CL	MKT3-V800G12-CL	MKT3-V1000G12-CL	MKT3-V1200G12-CL	MKT3-V1400G12-CL	
Power supply	V/Ph/Hz	220-240V/1/50					
Air flow	m³/h	1190/1015/806	1400/1082/816	1650/1201/746	1750/1222/912	2250/1952/1675	
	CFM	700/597/474	824/636/480	971/706/439	1029/719/537	1324/1148/985	
Standard external static pressure	Pa	12Pa (default); 30/50Pa a can be set through dial switch on the PCB or by wired controller					
Cooling	Capacity (H/M/L)	kW	6.50/6.04/5.09	8.02/6.65/5.37	9.05/7.10/4.97	10.08/7.25/6.02	11.11/10.58/9.77
	Water pressure drop (H/M/L)	kPa	22.0/19.0/15.6	32.00/26.06/18.05	32.00/22.01/11.71	27.0/20.7/14.0	33.00/29.29/25.92
	Water flow rate (H/M/L)	m³/h	1.19/1.05/0.91	1.36/1.17/0.94	1.58/1.26/0.88	1.69/1.44/1.16	2.02/1.84/1.71
Heating	Capacity (H/M/L)	kW	7.60/6.96/5.81	9.40/7.36/5.82	11.00/8.02/5.41	11.83/8.32/6.78	12.67/11.98/10.59
	Water pressure drop (H/M/L)	kPa	25.0/21.1/16.2	41.00/25.33/16.36	33.00/21.55/10.90	26.00/20.12/13.30	34.00/30.41/25.26
	Water flow rate (H/M/L)	m³/h	1.38/1.22/1.05	1.53/1.26/0.98	1.78/1.36/0.92	1.94/1.64/1.30	2.23/2.04/1.84
Power input (H/M/L)	W	75.0/52.0/33.0	75.0/43.0/23.0	119.0/54.0/19.0	119.0/54.0/29.0	119.0/90.0/64.0	
Auxiliary electric heater (AEH)	W	1500	2000	2000	2500	2500	
Sound pressure level	dB(A)	51/45/40	49.5/43/36	54.5/46/34	49.5/42.5/33.5	53/50/46.5	
Fan motor	Type	/	DC motor				
	Quantity	/	1				
Fan	Type	/	Centrifugal, forward-curved blades				
	Quantity	/	2	3	3	4	4
Coil	Row	/	3				
	Max. working pressure	MPa	1.6MPa				
	Diameter	mm	7				
Net dimensions (WxHxD)	mm	1178x243x482	1368x243x482	1368x243x482	1658x243x482	1898x243x482	
Packing size (WxHxD)	mm	1248x270x520	1438x270x520	1438x270x520	1728x270x520	1968x270x520	
Net weight	kg	23.5	27.7	27.7	33.8	37	
Gross weight	kg	26.8	30.7	30.7	38.3	41.5	
Water inlet/outlet pipe	inch	RC3/4					
Drain pipe	inch	ZG3/4					

Notes:

1. H: High fan speed; M: Medium fan speed; L: Low fan speed;
2. Cooling conditions : water inlet 7°C, water outlet 12°C, entering air temperature 27°C DB/19°C WB, with air return plenum and filter;
3. Heating conditions : water inlet 45°C, water outlet 40°C, entering air temperature 20°C DB, with air return plenum and filter;
4. Sound pressure level is tested in the semi-anechoic room with background noise is 17.5dB (A), when the unit is without accessories and running in dry condition, at 1m below & 1m front the vertical center line of the unit with 1m outlet duct;
5. Air flow is tested under dry condition, 20 C DB, with air return plenum and filter;
6. Left and right unit can be changed in the field, but cooling should be multiplied with correction factor 0.9;
7. The performance data on above sheet was tested under 220V~50Hz;
8. Auxiliary electric heater (AEH) is optional;
9. All specifications are subject to change by the manufacturer without prior notice.

2-Pipe 4-Row Duct

Model		MKT4-V200	MKT4-V300	MKT4-V400	MKT4-V500	MKT4-V600	MKT4-V800	MKT4-V1000	MKT4-V1200	
Power supply	V/Ph/Hz	220-240/1/50								
Air flow (H/M/L)	m ³ /h CFM	441/297/227 259/174/133	627/468/338 368/275/198	778/537/349 458/316/205	884/642/461 520/377/271	1056/793/575 621/466/338	1506/1084/822 885/637/483	1813/1341/932 1066/788/548	2134/1617/1119 1255/951/658	
Standard external static pressure	Pa	12Pa (default); 30/50Pa can be set through dial switch on PCB								
Cooling ¹	Capacity (H/M/L)	kW	2.22/1.59/1.2	3.19/2.58/1.87	4.06/3.26/2.41	4.46/3.56/2.78	5.87/4.78/3.68	6.65/5.04/3.61	7.98/6.19/4.37	9.76/7.81/5.72
	Water flow rate (H/M/L)	m ³ /h	0.40/0.30/0.23	0.57/0.47/0.34	0.72/0.59/0.43	0.80/0.63/0.50	1.06/0.86/0.65	1.19/0.88/0.64	1.47/1.12/0.78	1.78/1.41/1.02
	Water pressure drop (H/M/L)	kPa	2.4/1.5/1.0	5.2/3.6/2.4	8.4/5.9/3.5	11.6/8.1/5.6	19.4/13.6/8.5	8.8/5.1/2.8	13.8/8.6/4.8	22.3/15.0/9.0
	Power input (H/M/L)	W	17/9/6	21/12/7	29/16/9	43/23/14	51/25/12	61/27/16	93/49/21	109/50/22
Heating ²	Capacity (H/M/L)	kW	2.81/2/1.54	3.88/3.09/2.35	4.8/3.42/2.49	5.44/4.23/3.23	6.47/5.18/3.91	8.36/6.32/4.77	9.89/7.05/5.13	11.76/9.32/6.76
	Water flow rate (H/M/L)	m ³ /h	0.51/0.37/0.29	0.67/0.56/0.42	0.84/0.68/0.51	0.96/0.76/0.57	1.11/0.90/0.67	1.43/1.12/0.86	1.68/1.35/1.00	2.01/1.60/1.15
	Water pressure drop (H/M/L)	kPa	2.0/1.8/1.2	5.0/4.3/2.8	11.27/7.0/4.2	10.6/9.8/6.7	16.3/12.6/7.4	7.7/7.0/4.3	22.08/18.9/11.1	20.0/16.9/9.6
	Power input (H/M/L)	W	18/9/7	23/13/8	32/18/10	41/22/14	56/27/13	66/30/16	102/46/20	119/55/24
Heating ³	Capacity (H/M/L)	kW	3.23/2.32/1.75	4.5/3.6/2.68	5.6/4.59/3.36	6.25/4.88/3.74	7.72/6.19/4.68	9.55/7.14/5.23	11.55/9/6.46	14.34/11.31/8.3
	Water flow rate (H/M/L)	m ³ /h	0.40/0.30/0.23	0.57/0.47/0.34	0.72/0.59/0.43	0.80/0.63/0.50	1.06/0.86/0.65	1.19/0.88/0.64	1.47/1.12/0.78	1.78/1.41/1.02
	Water pressure drop (H/M/L)	kPa	3.0/1.2/0.7	5.9/3.1/1.9	9.1/4.9/2.8	14.1/7.6/5.5	17.9/11.3/7.0	10.9/4.5/2.5	15.4/7.5/4.1	24.9/13.5/13.5
	Power input (H/M/L)	W	19/9/6	23/13/8	32/18/10	42/21/11	56/27/13	67/29/16	103/46/20	121/54/23
Sound pressure level	0Pa (H/M/L)	dB(A)	37.3/27.4/22.2	39.6/32.5/25.0	41.1/34.5/26.4	44.8/37.2/29.8	46.1/39.4/30.7	47.4/39.1/32.1	50.4/42.7/33.1	50.7/43.8/34.5
Sound power level	0Pa (H/M/L)	dB(A)	50/41/33	50/44/35	52/47/38	56/49/41	57/50/42	58/50/43	62/55/46	62/55/46
Fan motor	Type	DC Motor								
	Quantity	1								
Fan	Type	Centrifugal, forward-curved Blades								
	Quantity	1								
	Row	4								
Coil	Max. working pressure	MPa	1.6							
	Diameter	mm	Ø9.52							
Net dimensions (WxHxD)	mm	741x241x522	841x241x522	941x241x522	941x241x522	1161x241x522	1461x241x522	1566x241x522	1856x241x522	
Packing size (WxHxD)	mm	790x260x555	890x260x560	990x260x560	990x260x560	1210x260x560	1510x260x560	1615x260x560	1905x260x560	
Net weight	kg	17.8	20	21.9	21.9	25	34.8	36.4	41.9	
Gross weight	kg	20.4	22.9	25.1	25.1	28.8	39.2	41.9	47.2	
Water inlet/outlet pipe	inch	RC3/4								
Drain pipe	inch	R3/4								

Notes:

H: High fan speed; M: Medium fan speed; L: Low fan speed.

1. Cooling mode (2 and 4-pipe coil): entering air temperature 27°C DB/1 9°C WB, entering/leaving water temperature 7°C /12°C.

2. Heating mode (1): (2-pipe coil): entering air temperature 20°C DB, entering/leaving water temperature 45/40°C.

3. Heating mode (2): (2-pipe coil): entering air temperature 20°C DB, enter water teperature/water flow 50°C/*(same water flow as in standard rating condition in cooling)

4. Sound pressure level is tested in a semi-anechoic test room.

5. The external static pressure test condition is 0 Pa.

4-Pipe 3-Row Duct

Model MKT3-		V200F	V300F	V400F	V500F	V600F	V800F	V1000F	V1200F		
Air flow (12,30,50Pa)	H/M/L	411/210/140	596/340/280	734/390/260	865/470/370	1022/670/440	1452/840/670	1824/1160/790	2134/1400/970		
	CFM	241/120/85	351/200/170	432/230/160	509/280/220	601/400/260	854/500/400	1073/690/470	1255/830/570		
External Static pressure	Pa	The factory default 12Pa,30/50Pa can adjust in the field									
Cooling	Capacity (12,30,50Pa)	H/M/L	1.4/1.1/0.8	2.2/1.7/1.5	2.5/2.0/1.5	3.0/2.4/1.9	4.2/3.5/2.5	5.3/4.1/3.1	6.7/5.4/3.9	8.2/6.5/4.6	
	Water flow rate	H/M/L	0.26/0.17/0.15	0.46/0.38/0.3	0.55/0.46/0.31	0.61/0.48/0.4	0.81/0.67/0.52	1.02/0.81/0.65	1.13/1.05/0.66	1.52/1.24/0.93	
	Water pressure drop	H/M/L	6.00/3.70/3.10	14.12/10.32/7.22	18.80/17.06/9.50	17.90/15.00/10.55	15.30/10.60/6.50	18.82/12.24/8.21	18.20/17.00/10.70	40.39/28.27/17.10	
Heating	Capacity (12,30,50Pa)	H/M/L	2.1/1.7/1.4	3.0/2.6/2.1	3.7/3.2/2.5	4.4/3.6/3.0	5.7/4.8/3.4	6.8/5.5/4.6	8.2/6.9/5.2	10.1/8.6/6.8	
	Water flow rate	H/M/L	0.23/0.2/0.18	0.31/0.3/0.28	0.39/0.34/0.3	0.42/0.37/0.31	0.54/0.47/0.37	0.66/0.58/0.53	0.76/0.75/0.6	0.92/0.8/0.64	
	Water pressure drop	H/M/L	8.00/7.00/6.40	15.50/14.78/14.67	21.19/16.56/13.19	24.63/19.40/14.23	44.76/34.7/22.63	20.71/15.47/11.21	16.70/12.80/8.10	27.82/21.59/14.56	
Power supply	V/Ph/Hz	220-240/1/50									
Power input	H	W	14	19	24	36	45	57	87	95	
Sound pressure level	12Pa	H/M/L	dB(A)	35/25/23	36/29/23	38/32/24	43/35/27	46/39/30	46/38/30	48/41/31	47/40/30
	30Pa	H/M/L	dB(A)	41/32/25	39/30/25	44/38/28	46/37/30	49/41/33	49/43/33	49/42/33	50/42/34
	50Pa	H/M/L	dB(A)	43/34/26	44/36/26	47/41/28	48/42/33	51/44/39	52/45/37	51/44/35	53/45/37
Fan motor	Type	DC Motor									
	Brand	Panasonic									
Fan	Model	WZDK50-38G-1 WZDK100-38GS-2 WZDK100-38GS-3 WZDK100-38GS-4 WZDK100-38GS-5 WZDK100-38GS-6 WZDK100-38GS-7 WZDK100-38GS-8									
	Quantity	1									
Fan	Type	Centrifugal, forward-curved Blades									
	Quantity	1									
	Row	3									
Coil	Max. Working pressure	MPa	1.6								
	Coil length x height	mm	485x203	585x206	685x206	685x206	905x206	1205x206	1310x206	1600x206	
Body	Fin spacing	mm	2.2								
	Fin type	Hydrophilic aluminum									
	Number of circuits	2									
Body	Diameter	mm	Ø9.52								
	Dimensions	WxHxD	741x241x522	841x241x522	941x241x522	941x241x522	1161x241x522	1461x241x522	1566x241x522	1856x241x522	
	Packing	WxHxD	790x260x555	890x260x560	990x260x560	990x260x560	1210x260x560	1510x260x560	1615x260x560	1905x260x560	
Pipe	Net weight	kg	17.2	19.5	21.5	21.5	24.2	33.5	35.2	39.7	
	Gross weight	kg	20.2	22.5	24.5	24.5	27.7	37.7	39.7	44.9	
Pipe connection	Water inlet/outlet pipe	inch	RC3/4								
	Drain pipe	inch	R3/4								

Notes:

1. H: high fan speed; M: medium fan speed; L: low fan speed.

2. Cooling conditions: Entering water 7°C, temperature rise 5°C, entering air temperature 27°C DB, 19°C WB.

3. Heating conditions: Entering water 65°C, temperature difference 10°C, enter air temperature 20°C DB, 15°C WB.

4. Noise is tested in semi-anechoic test room.

Wall Mounted Series



Model: 250/300/400/500/600 CFM



R05
Standard



KJR-29B
Optional

Features

- Display shut off (for Type A and P panels though Wireless Remote Controllers RM12F/BGF-E).
- Built-in 3-way electromagnetic valve.
- Remote controller as standard, wired controller is optional.
- Easy and low cost installation.
- The panel can be easily removed, simple maintenance and easy to change filter.
- Multi-directional outlet pipe feature: left/right/rear, to meet the needs of different rooms.
- Compatible with 0-10V control function.

Stylish panel, ideal for rooms with no or narrow ceilings.



Digital Display On/Off

Indoor unit displays can be shut off at night, creating a better environment for rest.



RM12F/BGF-E RM12F/BGF-E is optional

Multiple Fan Speeds

The DC Series comes with 3 fan speed option to meet the needs of different indoor conditions.

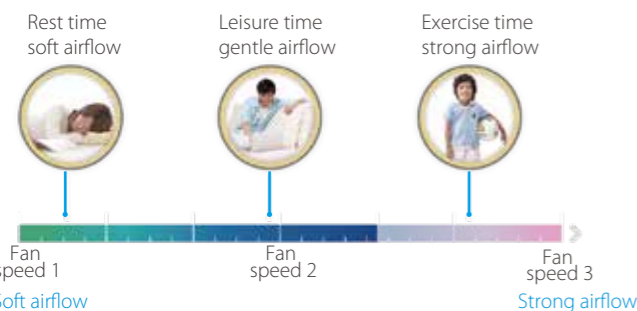

Auto Swing Louver

The Auto Swing Louver function ensures that the air direction corresponds to the mode selected.

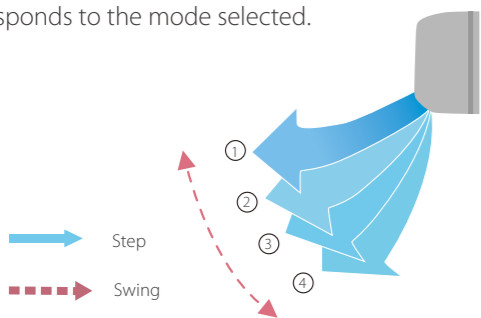

Control solutions

The fan coil units can be connected to Midea central controllers through the customized XYE port, also can be connected to Modbus gateway through the customized PQE port with Modbus RTU protocol.

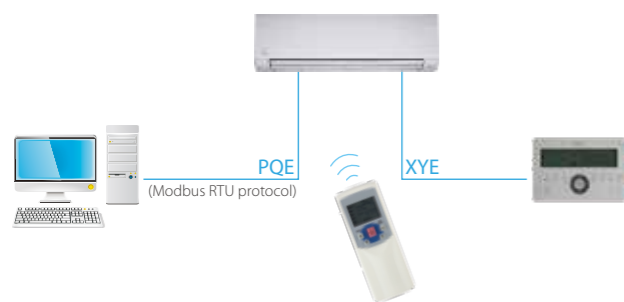

Variety stylish Panel

Variety stylish panel with three options (A Type, P Type), perfect fusion in all kinds of decoration.



Flexible Pipe Outlet Direction

Multi-outlet pipe method for both refrigerant pipe and drain pipe: left/right/rear, more flexible for installation.

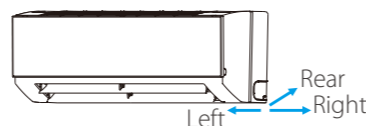

Easy Maintenance

Removable front panel making maintenance convenient.



Exposed Installation, No Need Ceilings

The Wall Mounted can be installed against wall, no need ceilings, simplifying installation.



Wall Mounted (A Type)



Model		MKG-V250C	MKG-V300C	MKG-V400C	MKG-V500C	MKG-V600C	
Power supply		V/Ph/Hz		220-240/1/50			
Air flow (H/M/L)		m³/h		825/689/590			
		CFM		289/267/235			
Cooling ¹	Capacity (H/M/L)	kW		2.7/2.59/2.39			
	Water flow rate (H/M/L)	m³/h		0.48/0.46/0.42			
	Water pressure drop (H/M/L)	kPa		31.6/28.6/25.4			
	Power input (H/M/L)	W		13/11/10			
Heating ²	Capacity (H/M/L)	kW		2.94/2.02/1.86			
	Water flow rate (H/M/L)	m³/h		0.51/0.49/0.46			
	Water pressure drop (H/M/L)	kPa		37.5/34.9/30.2			
	Power input (H/M/L)	W		12/11/9			
Heating ³	Capacity (H/M/L)	kW		3.29/3.03/2.63			
	Water flow rate (H/M/L)	m³/h		0.48/0.46/0.42			
	Water pressure drop (H/M/L)	kPa		32.70/30.3/26.5			
	Power input (H/M/L)	W		12/10/8			
Sound pressure level (H/M/L)	dB(A)		32/30/27		32/27/23		
Sound power level (H/M/L)	dB(A)		44/42/39		44/39/35		
Rated current	A		0.16		0.19		
Fan motor	Type	DC Motor		DC Motor		DC Motor	
	Quantity	1		1		1	
Fan	Type	Tangential fan		Tangential fan		Tangential fan	
	Quantity	1		1		1	
Coil	Row	2		2		2	
	Max. working pressure	MPa		1.6		1.6	
	Diameter	mm		Φ7		Φ7	
Net dimensions (WxHxD)	mm		915x290x230		915x290x230		
Packing size (WxHxD)	mm		1020x390x315		1020x390x315		
Net weight	kg		12.7		12.7		
Gross weight	kg		15.6		15.6		
Water inlet/outlet pipe	inch		G3/4		G3/4		
Drain pipe	mm		ODΦ20		ODΦ20		

Wall Mounted (P Type)



Model		MKG-V250D	MKG-V300D	MKG-V400D	MKG-V500D	MKG-V600D	
Power supply		V/Ph/Hz		220-240/1/50			
Air flow (H/M/L)		m³/h		825/689/590			
		CFM		289/267/235			
Cooling ¹	Capacity (H/M/L)	kW		2.7/2.59/2.39			
	Water flow rate (H/M/L)	m³/h		0.48/0.46/0.42			
	Water pressure drop (H/M/L)	kPa		31.6/28.6/25.4			
	Power input (H/M/L)	W		13/11/10			
Heating ²	Capacity (H/M/L)	kW		2.94/2.02/1.86			
	Water flow rate (H/M/L)	m³/h		0.51/0.49/0.46			
	Water pressure drop (H/M/L)	kPa		37.5/34.9/30.2			
	Power input (H/M/L)	W		12/11/9			
Heating ³	Capacity (H/M/L)	kW		3.29/3.03/2.63			
	Water flow rate (H/M/L)	m³/h		0.48/0.46/0.42			
	Water pressure drop (H/M/L)	kPa		32.70/30.3/26.5			
	Power input (H/M/L)	W		12/10/8			
Sound pressure level (H/M/L)	dB(A)		32/30/27		32/27/23		
Sound power level (H/M/L)	dB(A)		44/42/39		44/39/35		
Rated current	A		0.16		0.19		
Fan motor	Type	DC Motor		DC Motor		DC Motor	
	Quantity	1		1		1	
Fan	Type	Tangential fan		Tangential fan		Tangential fan	
	Quantity	1		1		1	
Coil	Row	2		2		2	
	Max. working pressure	MPa		1.6		1.6	
	Diameter	mm		Φ7		Φ7	
Net dimensions (WxHxD)	mm		915x290x230		915x290x230		
Packing size (WxHxD)	mm		1020x390x315		1020x390x315		
Net weight	kg		12.7		12.7		
Gross weight	kg		15.6		15.6		
Water inlet/outlet pipe	inch		G3/4		G3/4		
Drain pipe	mm		ODΦ20		ODΦ20		

Notes:
 Based on Eurovent conditions:
 H: High fan speed; M: Medium fan speed; L: Low fan speed.
 1 :Cooling mode (2 and 4-pipe coil): entering air temperature 27°C DB/1 9°C WB, entering/leaving water temperature 7°C /12°C, high fan speed.
 2 :Heating mode (1): (2-pipe coil): entering air temperature 20°C DB, entering/leaving water temperature 45/40°C, high fan speed.
 3 :Heating mode (2): (2-pipe coil): entering air temperature 20°C DB, enter water teperature/water flow 50°C/*(same water flow as in standard rating condition in cooling)

2nd Generation Ceiling&Floor series



Model: 150/250/350/500/700/800 CFM



KJR-75A
Optional

Features

- 3 or 4 rows coil are optional for whole series .
- 2-Pipe and 4-Pipe are optional for whole series.
- Ultra-thin with 200 mm thickness.
- Hysteresis temperature can be set in heating and cooling mode by PCB switch, field adjustable.
- With/without forced fan on can be set by PCB switch, field adjustable.
- The XYE port(Centralized) and PQE port (Modbus) are can be customized.
- 0-10V fan speed control port is optional.
- Floor standing/Horizontal/ Concealed type installation available (For floor standing : The footing is optional).
- Auto mode and 7 fan speed (by 75A wired controller).

Floor standing unit with multi casing options can be installed quickly and easily in new or existing facilities in a variety of applications.



Multiple Fan Speeds

The DC Series comes with 3 fan speed option to meet the needs of different indoor conditions. (7 fan speed should be used KJR-75A wired controller)

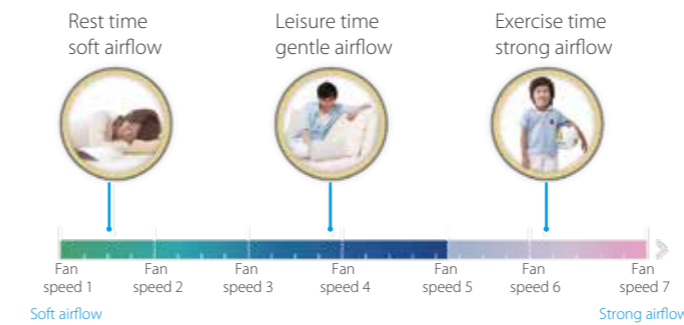

Auto restart

In the event of a sudden power failure during operation, unit restarts automatically and the unit will operate based on the previous setting (operating mode, temperature setting and fan speed).

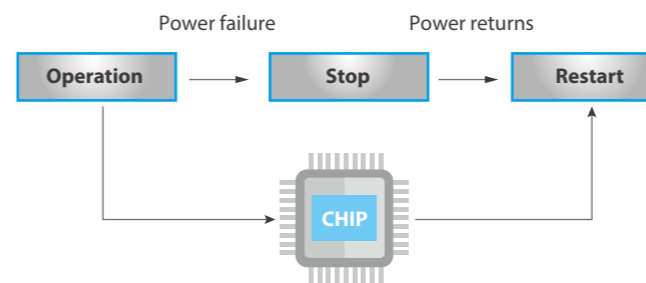

Control solutions

The fan coil units can be connected to Midea central controllers through the customized XYE port, also can be connected to Modbus gateway through the customized PQE port with Modbus RTU protocol.

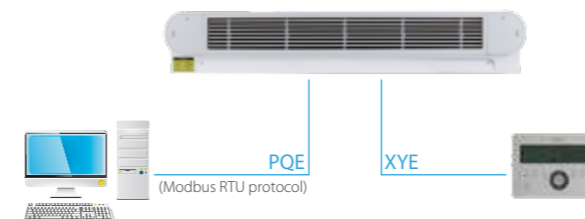

Multiple Appearance Options

The Floor Standing Unit has three appearance options to meet different installation requirement, the H3 (concealed) unit is designed to be concealed in walls while the H1 (front air intake) and H2 (underside air intake) offer a choice of air intake options.

Concealed Type
H3 Series



Exposed Type
(air return from bottom)
H2 Series



Exposed Type
(air return from side)
H1 Series



Ease of Installation and Maintenance

The ceiling and floor unit offers exposed installation. The installation and maintenance is easy. The maintenance of the machine is quite easy and the key components can be accessed from the bottom of the machine.



Ceiling and Floor Installation Option

The unit is uniquely designed with the possibility to be installed beneath the ceiling or sitting on the floor to suit any interior design requirements.



2- Pipe 2nd Generation Ceiling&Floor

Model		MKH1-V150-R3	MKH1-V150-R4	MKH1-V250-R3	MKH1-V250-R4	MKH1-V350-R3	MKH1-V350-R4	
Power supply	V/Ph/Hz	220-240/1/50						
Air flow (H/M/L)	m ³ /h	245/160/135	245/180/130	380/245/140	380/240/110	580/435/310	580/430/300	
	CFM	144/94/79	144/106/76	224/144/82	224/141/65	341/256/182	341/253/176	
External static pressure	Pa	0						
Cooling	Capacity (H/M/L)	kW	1.44/1.01/0.88	1.87/1.59/1.16	2.23/1.84/1.13	2.55/1.90/1.26	3.41/2.81/2.16	3.80/3.11/2.36
	Water flow rate (H/M/L)	m ³ /h	0.25/0.17/0.15	0.32/0.27/0.2	0.38/0.32/0.19	0.44/0.33/0.22	0.58/0.48/0.37	0.65/0.53/0.40
	Water pressure drop (H/M/L)	kPa	13.4/7.9/6.0	26.1/20.1/11.8	12.7/9.5/4.4	23.2/13.5/6.6	33.4/24.0/15.0	36.5/25.3/15.0
Heating	Capacity (H/M/L)	kW	1.50/1.02/0.88	1.97/1.68/1.20	2.47/2.00/1.27	2.63/1.92/1.27	3.70/3.02/2.29	3.90/3.13/2.43
	Water flow rate (H/M/L)	m ³ /h	0.26/0.17/0.15	0.34/0.29/0.21	0.42/0.34/0.22	0.45/0.33/0.22	0.63/0.52/0.39	0.67/0.54/0.40
	Water pressure drop (H/M/L)	kPa	14.5/7.3/5.6	24.0/18.8/9.9	13.6/9.8/4.3	21.8/12.2/5.9	34.2/23.8/14.5	35.6/24.7/13.9
Power input (H/M/L)	W	19/15/10	20/16/11	20/13/10	21/12/8	27/18/11	30/18/12	
Sound pressure level(H/M/L)	dB(A)	34/23/21	39/33/26	30/22/14	33/26/17	39/32/24	39/32/24	
Sound power level(H/M/L)	dB(A)	47/36/34	52/46/39	43/35/27	46/38/30	52/45/37	52/45/37	
Fan motor	Type	Low noise DC fan motor						
	Quantity	1	1	1	1	1	1	
Fan	Type	Centrifugal, forward-curved Blades						
	Quantity	1	1	2	2	2	2	
Coil	Row	3	4	3	4	3	4	
	Max. working pressure	MPa	1.6	1.6	1.6	1.6	1.6	1.6
	Diameter	mm	Ø7.94	Ø7.94	Ø7.94	Ø7.94	Ø7.94	Ø7.94
Body	Net dimensions (WxHxD)	mm	790x495x211	790x495x211	1020x495x211	1020x495x211	1240x495x211	1240x495x211
	Packing size (WxHxD)	mm	895x595x300	895x595x300	1125x595x300	1125x595x300	1345x595x300	1345x595x300
	Net weight	kg	18.0	18.5	21.5	22.0	25.5	26.5
	Gross weight	kg	23.5	24.0	27.5	28.0	32.5	33.5
Water inlet/outlet pipe	inch	G3/4	G3/4	G3/4	G3/4	G3/4	G3/4	
Drain pipe	mm	ODØ18.5	ODØ18.5	ODØ18.5	ODØ18.5	ODØ18.5	ODØ18.5	

Model		MKH1-V500-R3	MKH1-V500-R4	MKH1-V700-R3	MKH1-V700-R4	MKH1-V800-R3	MKH1-V800-R4	
Power supply	V/Ph/Hz	220-240/1/50						
Air flow (H/M/L)	m ³ /h	780/550/380	780/560/390	1050/750/420	1050/770/460	1150/850/570	1150/860/600	
	CFM	459/324/224	459/329/229	618/441/247	618/453/271	676/500/335	676/506/353	
External static pressure	Pa	0						
Cooling	Capacity (H/M/L)	kW	4.25/3.43/2.67	4.73/3.82/2.85	4.94/3.94/2.77	5.60/4.58/3.19	6.21/5.17/3.86	7.30/5.88/4.28
	Water flow rate (H/M/L)	m ³ /h	0.73/0.59/0.46	0.81/0.65/0.49	0.85/0.68/0.47	0.96/0.79/0.55	1.06/0.89/0.66	1.25/1.01/0.73
	Water pressure drop (H/M/L)	kPa	53.5/35.8/24.1	53.0/35.9/21.2	44.7/29.5/15.6	28.9/19.2/10.1	37.3/28.5/16.4	63.0/40.8/22.5
Heating	Capacity (H/M/L)	kW	4.64/3.65/2.77	5.12/3.98/2.96	5.29/4.20/2.96	6.22/4.95/3.37	6.80/5.46/3.98	7.70/6.02/4.29
	Water flow rate (H/M/L)	m ³ /h	0.80/0.63/0.47	0.88/0.68/0.51	0.91/0.72/0.51	1.07/0.85/0.58	1.17/0.94/0.68	1.32/1.03/0.74
	Water pressure drop (H/M/L)	kPa	53.6/36.4/22.0	52.0/35.6/20.0	49.0/33.2/17.0	33.2/22.5/11.0	39.7/27.0/15.4	55.0/36.4/19.2
Power input (H/M/L)	W	50/26/15	52/28/15	98/45/18	99/50/20	105/50/24	105/50/23	
Sound pressure level (H/M/L)	dB(A)	46/39/30	46/39/30	52/43/32	52/42/33	53/46/36	53/46/36	
Sound power level (H/M/L)	dB(A)	59/52/43	59/52/43	65/57/45	65/56/46	66/59/49	65/59/49	
Fan motor	Type	Low noise DC fan motor						
	Quantity	1	1	1	1	1	1	
Fan	Type	Centrifugal, forward-curved Blades						
	Quantity	2	2	3	3	3	3	
Coil	Row	3	4	3	4	3	4	
	Max. working pressure	MPa	1.6	1.6	1.6	1.6	1.6	1.6
	Diameter	mm	Ø7.94	Ø7.94	Ø7.94	Ø7.94	Ø7.94	Ø7.94
Body	Net dimensions (WxHxD)	mm	1240x495x211	1240x495x211	1360x495x211	1360x495x211	1360x495x211	1360x495x211
	Packing size (WxHxD)	mm	1345x595x300	1345x595x300	1465x595x300	1465x595x300	1465x595x300	1465x595x300
	Net weight	kg	25.5	26.5	28.5	29.5	32.5	34.5
	Gross weight	kg	32.5	33.5	36.0	37.0	41.0	42.5
Water inlet/outlet pipe	inch	G3/4	G3/4	G3/4	G3/4	G3/4	G3/4	
Drain pipe	mm	ODØ18.5	ODØ18.5	ODØ18.5	ODØ18.5	ODØ18.5	ODØ18.5	

Notes:

1. H: High fan speed; M: Medium fan speed; L: Low fan speed.
2. Cooling conditions: Entering water 7°C, leaving water 12°C, Entering air temperature 27°C DB/19°C WB.
Heating conditions: Entering water 45°C, leaving water 40°C, Entering air temperature 20°C DB/15°C WB.
3. Noise is tested in a reverberation chamber test room.

2- Pipe 2nd Generation Ceiling&Floor

Model		MKH2-V150-R3	MKH2-V150-R4	MKH2-V250-R3	MKH2-V250-R4	MKH2-V350-R3	MKH2-V350-R4	
Power supply	V/Ph/Hz	220-240/1/50						
Air flow (H/M/L)	m ³ /h	255/170/150	255/210/150	400/315/190	425/300/190	595/470/340	595/450/310	
	CFM	150/100/88	150/124/88	235/185/112	250/176/112	350/276/200	350/265/182	
External static pressure	Pa	0						
Cooling	Capacity (H/M/L)	kW	1.50/1.06/0.92	1.95/1.66/1.21	2.35/1.94/1.19	2.85/2.13/1.41	3.50/2.89/2.22	3.90/3.20/2.43
	Water flow rate (H/M/L)	m ³ /h	0.26/0.18/0.16	0.33/0.28/0.21	0.40/0.34/0.21	0.49/0.37/0.24	0.60/0.50/0.38	0.67/0.55/0.42
	Water pressure drop (H/M/L)	kPa	13.94/8.21/6.16	27.2/20.88/12.2	13.33/9.98/4.59	26.01/15.06/7.41	34.08/24.63/15.39	37.4/25.91/15.37
Heating	Capacity (H/M/L)	kW	1.57/1.07/0.92	2.05/1.75/1.25	2.60/2.11/1.34	2.95/2.15/1.42	3.80/3.10/2.35	4.00/3.22/2.39
	Water flow rate (H/M/L)	m ³ /h	0.27/0.19/0.16	0.35/0.30/0.22	0.45/0.37/0.23	0.51/0.37/0.24	0.65/0.53/0.40	0.70/0.56/0.43
	Water pressure drop (H/M/L)	kPa	15.1/7.63/5.84	25.34/19.65/10.25	14.31/10.33/4.5	24.38/13.65/6.64	35.13/24.41/14.82	36.52/25.34/14.22
Power input (H/M/L)	W	15/9/8	20/14/9	17/12/7	20/11/8	26/16/10	29/17/12	
Sound pressure level (H/M/L)	dB(A)	34/24/21	39/33/25	29/24/18	32/23/19	38/32/23	40/34/30	
Sound power level (H/M/L)	dB(A)	47/36/34	52/46/38	43/37/29	46/37/29	52/44/36	52/45/36	
Fan motor	Type	Low noise DC fan motor						
	Quantity	1	1	1	1	1	1	
Fan	Type	Centrifugal, forward-curved Blades						
	Quantity	1	1	2	2	2	2	
Coil	Row	3	4	3	4	3	4	
	Max. working pressure	MPa	1.6	1.6	1.6	1.6	1.6	1.6
	Diameter	mm	Ø7.94	Ø7.94	Ø7.94	Ø7.94	Ø7.94	Ø7.94
Body	Net dimensions (WxHxD)	mm	790x495x200	790x495x200	1020x495x200	1020x495x200	1240x495x200	1240x495x200
	Packing size (WxHxD)	mm	895x595x300	895x595x300	1125x595x300	1125x595x300	1345x595x300	1345x595x300
	Net weight	kg	18.0	18.5	21.5	22.0	25.5	26.5
	Gross weight	kg	23.5	24.0	27.5	28.0	32.5	33.5
Water inlet/outlet pipe	inch	G3/4	G3/4	G3/4	G3/4	G3/4	G3/4	
Drain pipe	mm	ODØ18.5	ODØ18.5	ODØ18.5	ODØ18.5	ODØ18.5	ODØ18.5	

Model		MKH2-V500-R3	MKH2-V500-R4	MKH2-V700-R3	MKH2-V700-R4	MKH2-V800-R3	MKH2-V800-R4	
Power supply	V/Ph/Hz	220-240/1/50						
Air flow (H/M/L)	m ³ /h	790/580/410	800/600/420	1190/855/505	1190/875/530	1360/1015/685	1300/980/680	
	CFM	488/359/253	471/353/247	700/503/297	700/515/312	800/597/403	765/576/400	
External static pressure	Pa	0						
Cooling	Capacity (H/M/L)	kW	4.30/3.48/2.71	4.85/3.92/2.93	5.60/4.47/3.14	6.35/5.19/3.62	7.35/6.12/4.57	8.25/6.65/4.84
	Water flow rate (H/M/L)	m ³ /h	0.74/0.60/0.47	0.83/0.67/0.51	0.96/0.77/0.54	1.09/0.90/0.63	1.27/1.05/0.79	1.43/1.14/0.83
	Water pressure drop (H/M/L)	kPa	54.22/36.22/22.78	54.33/36.81/21.77	50.67/33.38/17.73	32.77/21.75/11.43	44.12/33.7/19.41	71.43/46.17/25.39
Heating	Capacity (H/M/L)	kW	4.70/3.70/2.81	5.25/4.09/3.04	6.00/4.77/3.36	7.05/5.61/3.83	8.05/6.46/4.71	8.37/6.81/4.85
	Water flow rate (H/M/L)	m ³ /h	0.81/0.64/0.48	0.91/0.71/0.53	1.04/0.83/0.59	1.22/0.98/0.67	1.39/1.12/0.82	1.51/1.18/0.83
	Water pressure drop (H/M/L)	kPa	54.29/36.87/22.32	53.44/36.54/20.47	55.49/37.66/19.27	37.61/25.47/12.5	46.88/31.9/18.16	62.61/41.06/21.68
Power input (H/M/L)	W	50/25/14	52/27/14	96/43/18	93/46/19	113/51/22	102/52/22	
Sound pressure level (H/M/L)	dB(A)	46/38/30	45/39/30	50/42/31	50/43/31	51/44/33	50/43/33	
Sound power level (H/M/L)	dB(A)	59/51/43	59/51/43	64/56/45	62/56/46	63/58/49	63/57/47	
Fan motor	Type	Low noise DC fan motor						
	Quantity	1	1	1	1	1	1	
Fan	Type	Centrifugal, forward-curved Blades						
	Quantity	2	2	3	3	3	3	
Coil	Row	3	4	3	4	3	4	
	Max. working pressure	MPa	1.6	1.6	1.6	1.6	1.6	1.6
	Diameter	mm	Ø7.94	Ø7.94	Ø7.94	Ø7.94	Ø7.94	Ø7.94
Body	Net dimensions (WxHxD)	mm	1240x495x200	1240x495x200	1360x495x200	1360x495x200	1360x591x200	1360x591x200
	Packing size (WxHxD)	mm	1345x595x300	1345x595x300	1465x595x300	1465x595x300	1465x695x300	1465x695x300
	Net weight	kg	25.5	26.5	28.5	29.5	32.5	34.5
	Gross weight	kg	32.5	33.5	36.0	37.0	41.0	42.5
Water inlet/outlet pipe	inch	G3/4	G3/4	G3/4	G3/4	G3/4	G3/4	
Drain pipe	mm	ODØ18.5	ODØ18.5	ODØ18.5	ODØ18.5	ODØ18.5	ODØ18.5	

Notes:

1. H: High fan speed; M: Medium fan speed; L: Low fan speed.
2. Cooling conditions: Entering water 7°C, leaving water 12°C, Entering air temperature 27°C DB/19°C WB.
Heating conditions: Entering water 45°C, leaving water 40°C, Entering air temperature 20°C DB/15°C WB.
3. Noise is tested in a reverberation chamber test room.

2- Pipe 2nd Generation Ceiling&Floor

Model		MKH3-V150-R3	MKH3-V150-R4	MKH3-V250-R3	MKH3-V250-R4	MKH3-V350-R3	MKH3-V350-R4	
Power supply	V/Ph/Hz	220-240/1/50						
Air flow (H/M/L)	m³/h	255/170/150	255/210/150	400/315/190	425/300/190	595/470/340	595/450/310	
	CFM	150/100/88	150/124/88	235/185/112	250/176/112	350/276/200	350/265/182	
External static pressure	Pa	12						
Cooling	Capacity (H/M/L)	kW	1.50/1.06/0.92	1.95/1.66/1.21	2.35/1.94/1.19	2.85/2.13/1.41	3.50/2.89/2.22	3.90/3.20/2.43
	Water flow rate (H/M/L)	m³/h	0.26/0.18/0.16	0.33/0.28/0.21	0.40/0.34/0.21	0.49/0.37/0.24	0.60/0.50/0.38	0.67/0.55/0.42
	Water pressure drop (H/M/L)	kPa	13.94/8.21/6.16	27.2/20.88/12.2	13.33/9.98/4.59	26.01/15.06/7.41	34.08/24.63/15.39	37.4/25.91/15.37
Heating	Capacity (H/M/L)	kW	1.57/1.07/0.92	2.05/1.75/1.25	2.60/2.11/1.34	2.95/2.15/1.42	3.80/3.10/2.35	4.00/3.22/2.50
	Water flow rate (H/M/L)	m³/h	0.27/0.19/0.16	0.35/0.30/0.22	0.45/0.37/0.23	0.51/0.37/0.24	0.65/0.53/0.40	0.70/0.56/0.43
	Water pressure drop (H/M/L)	kPa	15.1/7.63/5.84	25.34/19.65/10.25	14.31/10.33/4.5	24.38/13.65/6.64	35.13/24.41/14.82	36.52/25.34/14.22
Power input (H/M/L)	W	15/9/8	20/14/9	17/12/7	19/11/8	27/16/10	28/17/12	
Sound pressure level (H/M/L)	dB(A)	34/24/21	39/33/25	29/24/18	32/23/19	38/32/23	40/34/30	
Sound power level (H/M/L)	dB(A)	47/36/34	52/46/38	43/37/29	46/37/29	52/44/36	52/45/36	
Fan motor	Type	Low noise DC fan motor						
	Quantity	1	1	1	1	1	1	
Fan	Type	Centrifugal, forward-curved Blades						
	Quantity	1	1	2	2	2	2	
Coil	Row	3	4	3	4	3	4	
	Max. working pressure	MPa	1.6	1.6	1.6	1.6	1.6	1.6
	Diameter	mm	Ø7.94	Ø7.94	Ø7.94	Ø7.94	Ø7.94	Ø7.94
Body	Net dimensions (WxHxD)	mm	628x455x200	628x455x200	858x455x200	858x455x200	1078x455x200	1078x455x200
	Packing size (WxHxD)	mm	755x555x255	755x555x255	985x555x255	985x555x255	1205x555x255	1205x555x255
	Net weight	kg	11.8	12.1	13.9	14.8	17.3	18.2
	Gross weight	kg	16.1	16.4	19.4	20.3	24.0	24.9
Water inlet/outlet pipe	inch	G3/4	G3/4	G3/4	G3/4	G3/4	G3/4	
Drain pipe	mm	ODØ18.5	ODØ18.5	ODØ18.5	ODØ18.5	ODØ18.5	ODØ18.5	

Model		MKH3-V500-R3	MKH3-V500-R4	MKH3-V700-R3	MKH3-V700-R4	MKH3-V800-R3	MKH3-V800-R4	
Power supply	V/Ph/Hz	220-240/1/50						
Air flow (H/M/L)	m³/h	790/580/410	790/600/420	1190/855/505	1190/875/530	1360/1015/685	1360/980/680	
	CFM	488/359/253	471/353/247	700/503/297	700/515/312	800/597/403	765/576/400	
External static pressure	Pa	12						
Cooling	Capacity (H/M/L)	kW	4.30/3.48/2.71	4.85/3.92/2.93	5.60/4.47/3.14	6.35/5.19/3.62	7.35/6.12/4.57	8.25/6.65/4.84
	Water flow rate (H/M/L)	m³/h	0.74/0.60/0.47	0.83/0.67/0.51	0.96/0.77/0.54	1.09/0.90/0.63	1.27/1.05/0.79	1.43/1.14/0.83
	Water pressure drop (H/M/L)	kPa	54.22/36.22/22.78	54.33/36.81/21.77	50.67/33.38/17.73	32.77/21.75/11.43	44.12/33.7/19.41	71.43/46.17/25.39
Heating	Capacity (H/M/L)	kW	4.70/3.70/2.81	5.25/4.09/3.04	6.00/4.77/3.36	7.05/5.61/3.83	8.05/6.46/4.71	8.70/6.81/4.85
	Water flow rate (H/M/L)	m³/h	0.81/0.64/0.48	0.91/0.71/0.53	1.04/0.83/0.59	1.22/0.98/0.67	1.39/1.12/0.82	1.51/1.18/0.83
	Water pressure drop (H/M/L)	kPa	54.29/36.87/22.32	53.44/36.54/20.47	55.49/37.66/19.27	37.61/25.47/12.5	46.88/31.9/18.16	62.61/41.06/21.68
Power input (H/M/L)	W	50/25/14	50/27/14	100/43/18	97/47/19	113/53/22	112/49/22	
Sound pressure level (H/M/L)	dB(A)	46/38/30	45/39/30	50/42/31	50/43/31	51/44/33	50/43/33	
Sound power level (H/M/L)	dB(A)	59/51/43	59/51/43	64/56/45	62/56/46	63/58/49	63/57/47	
Fan motor	Type	Low noise DC fan motor						
	Quantity	1	1	1	1	1	1	
Fan	Type	Centrifugal, forward-curved Blades						
	Quantity	2	2	3	3	3	3	
Coil	Row	3	4	3	4	3	4	
	Max. working pressure	MPa	1.6	1.6	1.6	1.6	1.6	1.6
	Diameter	mm	Ø7.94	Ø7.94	Ø7.94	Ø7.94	Ø7.94	Ø7.94
Body	Net dimensions (WxHxD)	mm	1078x455x200	1078x455x200	1198x455x200	1198x455x200	1198x551x200	1198x551x200
	Packing size (WxHxD)	mm	1205x555x255	1205x555x255	1325x555x255	1325x555x255	1325x650x255	1325x650x255
	Net weight	kg	17.3	18.2	19.6	20.8	23.1	24.3
	Gross weight	kg	24.0	24.9	26.4	27.6	30.2	31.4
Water inlet/outlet pipe	inch	G3/4	G3/4	G3/4	G3/4	G3/4	G3/4	
Drain pipe	mm	ODØ18.5	ODØ18.5	ODØ18.5	ODØ18.5	ODØ18.5	ODØ18.5	

Notes:
 1. H: High fan speed; M: Medium fan speed; L: Low fan speed.
 2. Cooling conditions: Entering water 7°C, leaving water 12°C, Entering air temperature 27°C DB/19°C WB.
 Heating conditions: Entering water 45°C, leaving water 40°C, Entering air temperature 20°C DB/15°C WB.
 3. Noise is tested in a reverberation chamber test room.
 4. H3 series test with concealed tooling.

4- Pipe 2nd Generation Ceiling&Floor

Model		MKH1-V150F-R4	MKH1-V250F-R4	MKH1-V350F-R4	MKH1-V500F-R4	MKH1-V700F-R4	MKH1-V800F-R4	
Power supply	V/Ph/Hz	220-240/1/50						
Air flow (H/M/L)	m³/h	245/180/130	380/240/110	580/430/300	780/560/390	1050/770/460	1150/860/600	
	CFM	144/106/76	224/141/65	341/253/176	459/329/229	618/453/271	676/506/353	
External static pressure	Pa	0						
Cooling	Capacity (H/M/L)	kW	1.63/1.38/0.91	2.41/1.73/0.99	3.70/3.10/2.26	4.49/3.66/2.76	5.34/4.41/3.02	6.77/5.48/4.02
	Water flow rate (H/M/L)	m³/h	0.28/0.24/0.16	0.41/0.30/0.17	0.63/0.53/0.38	0.77/0.63/0.47	0.92/0.76/0.52	1.16/0.94/0.69
	Water pressure drop (H/M/L)	kPa	17.5/13.74/7.5	15.2/9.73/3.51	38.2/28.35/16.91	54.8/39.04/23.84	47.4/36.96/19.07	42.5/32.56/18.32
Heating	Capacity (H/M/L)	kW	1.35/1.18/0.91	2.06/1.45/1.02	2.81/2.43/1.95	3.27/2.81/2.30	4.06/3.48/2.66	6.63/5.7/4.62
	Water flow rate (H/M/L)	m³/h	0.12/0.10/0.08	0.18/0.13/0.09	0.24/0.21/0.17	0.28/0.24/0.20	0.35/0.3/0.23	0.57/0.49/0.40
	Water pressure drop (H/M/L)	kPa	10.3/8.5/5.3	25.2/18.45/8.5	54.0/43/28.5	67.8/54.65/37.3	116.76/104.19/56.23	63.4/56.17/33.1
Power input (H/M/L)	W	20/16/11	21/12/8	30/18/12	52/28/15	99/50/20	105/50/23	
Sound pressure level (H/M/L)	dB(A)	39/33/26	33/26/17	39/32/24	46/39/30	52/42/33	53/46/36	
Sound power level (H/M/L)	dB(A)	52/46/39	46/38/30	52/45/37	59/52/43	65/56/46	65/59/49	
Fan motor	Type	Low noise DC fan motor						
	Quantity	1	1	1	1	1	1	
Fan	Type	Centrifugal, forward-curved Blades						
	Quantity	1	2	2	2	3	3	
Coil	Row	4	4	4	4	4	4	
	Max. working pressure	MPa	1.6	1.6	1.6	1.6	1.6	1.6
	Diameter	mm	Ø7.94	Ø7.94	Ø7.94	Ø7.94	Ø7.94	Ø7.94
Body	Net dimensions (WxHxD)	mm	790x495x211	1020x495x211	1240x495x211	1240x495x211	1360x495x211	1360x591x211
	Packing size (WxHxD)	mm	895x595x300	1125x595x300	1345x595x300	1345x595x300	1465x595x300	1465x695x300
	Net weight	kg	19.0	22.5	27.0	27.0	30.0	35.0
	Gross weight	kg	24.5	28.5	34.0	34.0	37.5	43.0
Water inlet/outlet pipe	inch	Cold water: G3/4; Hot water: G1/2						
Drain pipe	mm	ODØ18.5	ODØ18.5	ODØ18.5	ODØ18.5	ODØ18.5	ODØ18.5	

Model		MKH2-V150F-R4	MKH2-V250F-R4	MKH2-V350F-R4	MKH2-V500F-R4	MKH2-V700F-R4	MKH2-V800F-R4	
Power supply	V/Ph/Hz	220-240/1/50						
Air flow (H/M/L)	m³/h	255/206/134	425/280/158	595/461/324	800/595/417	1190/887/564	1300/969/661	
	CFM	150/121/79	250/165/93	350/271/191	471/350/245	700/522/332	765/570/389	
External static pressure	Pa	0						
Cooling	Sensible Capacity (H/M/L)	kW	1.30/1.07/0.64	1.90/1.30/0.70	2.80/2.30/1.61	3.50/2.75/2.01	4.80/3.88/2.53	5.90/4.60/3.30
	Capacity (H/M/L)	kW	1.70/1.44/0.95	2.70/1.94/1.10	3.80/3.18/2.32	4.60/3.75/2.83	6.05/5.00/3.43	7.65/6.19/4.54
	Water flow rate	m³/h	0.29/0.25/0.16	0.46/0.33/0.19	0.65/0.55/0.40	0.79/0.64/0.49	1.04/0.86/0.59	1.31/1.06/0.78
	Water pressure drop	kPa	18.16/13.74/7.50	16.97/9.73/3.51	39.17/28.35/16.91	56.18/39.04/23.84	53.66/36.96/19.07	48.07/32.56/18.32
Heating	Capacity (H/M/L)	kW	1.40/1.23/0.95	2.30/1.78/1.22	2.88/2.49/2.00	3.35/2.88/2.36	4.60/3.95/3.02	7.50/6.44/5.22
	Water flow rate	m³/h	0.12/0.11/0.08	0.20/0.15/0.10	0.25/0.21/0.17	0.29/0.25/0.20	0.39/0.34/0.26	0.64/0.55/0.45
	Water pressure drop	kPa	10.74/8.50/5.49	28.16/18.45/10.08	55.37/43.00/29.20	69.57/54.65/38.21	132.32/104.19/63.73	71.63/56.17/37.44
Power input (H/M/L)	W	20/14/9	20/11/8	29/17/11	52/28/15	92/46/19	102/49/22	
Sound pressure level (H/M/L)	dB(A)	39/33/25	32/23/19	40/34/30	45/39/30	50/43/31	50/43/33	
Sound power level (H/M/L)	dB(A)	52/46/38	46/37/29	52/45/36	59/52/43	63/58/46	64/57/47	
Rated current	A	0.21	0.22	0.28	0.51	0.79	0.87	
Fan motor	Type	Low noise DC fan motor						
	Quantity	1	1	1	1	1	1	
Fan	Type	Centrifugal, forward-curved Blades						
	Quantity	1	2	2	2	3	3	
Coil	Row	4	4	4	4	4	4	
	Max. working pressure	MPa	1.6	1.6	1.6	1.6	1.6	1.6
	Diameter	mm	Ø7.94	Ø7.94	Ø7.94	Ø7.94	Ø7.94	Ø7.94
Body	Net dimensions (WxHxD)	mm	790x495x200	1020x495x200	1240x495x200	1240x495x200	1360x495x200	1360x591x200
	Packing size (WxHxD)	mm	895x595x300	1125x595x300	1345x595x300	1345x595x300	1465x595x300	1465x695x300
	Net weight	kg	19.0	22.5	27.0	27.0	30.0	35.0
	Gross weight	kg	24.5	28.5	34.0	34.0	37.5	43.0
Water inlet/outlet pipe	inch	Cold water: G3/4; Hot water: G1/2						
Drain pipe	mm	ODØ18.5						

Notes:
 1. H: High fan speed; M: Medium fan speed; L: Low fan speed.
 2. Cooling conditions: Entering water 7°C, leaving water 12°C, Entering air temperature 27°C DB/19°C WB.
 Heating conditions: Entering water 65°C, leaving water 55°C, Entering air temperature 20°C DB/15°C WB.
 3. Noise is tested in a reverberation chamber test room.

Model		MKH3-V150F-R4	MKH3-V250F-R4	MKH3-V350F-R4	MKH3-V500F-R4	MKH3-V700F-R4	MKH3-V800F-R4	
Power supply	V/Ph/Hz	220-240/1/50						
Air flow (H/M/L)	m³/h	255/206/134	425/280/158	595/461/324	800/595/417	1190/887/564	1300/969/661	
	CFM	150/121/79	250/165/93	350/271/191	471/350/245	700/522/332	765/570/389	
External static pressure	Pa	12						
Cooling	Sensible Capacity(H/M/L)	kW	1.30/1.07/0.64	1.90/1.30/0.70	2.80/2.30/1.61	3.50/2.75/2.01	4.80/3.88/2.53	5.90/4.60/3.30
	Capacity (H/M/L)	kW	1.70/1.44/0.95	2.70/1.94/1.10	3.80/3.18/2.32	4.60/3.75/2.83	6.05/5.00/3.43	7.65/6.19/4.54
	Water flow rate	m³/h	0.29/0.25/0.16	0.46/0.33/0.19	0.65/0.55/0.40	0.79/0.64/0.49	1.04/0.86/0.59	1.31/1.06/0.78
	Water pressure drop	kPa	18.16/13.74/7.50	16.97/9.73/3.51	39.17/28.35/16.91	56.18/39.04/23.84	53.66/36.96/19.07	48.07/32.56/18.32
Heating	Capacity (H/M/L)	kW	1.40/1.23/0.95	2.30/1.78/1.22	2.88/2.49/2.00	3.35/2.88/2.36	4.60/3.95/3.02	7.50/6.44/5.22
	Water flow rate	m³/h	0.12/0.11/0.08	0.20/0.15/0.10	0.25/0.21/0.17	0.29/0.25/0.20	0.39/0.34/0.26	0.64/0.55/0.45
	Water pressure drop	kPa	10.74/8.50/5.49	28.16/18.45/10.08	55.37/43.00/29.20	69.57/54.65/38.21	132.32/104.19/63.73	71.63/56.17/37.44
Power input	(H/M/L) W	20/14/9	20/11/8	29/17/11	52/28/15	92/46/19	102/49/22	
Sound pressure level	(H/M/L) dB(A)	39/33/25	32/23/19	40/34/30	45/39/30	50/43/31	50/43/33	
Sound power level	(H/M/L) dB(A)	52/46/38	46/37/29	52/45/36	59/51/43	62/56/46	63/57/47	
Rated current	A	0.21	0.22	0.28	0.51	0.79	0.87	
Fan motor	Type	Low noise DC fan motor						
	Quantity	1	1	1	1	1	1	
Fan	Type	Centrifugal, forward-curved Blades						
	Quantity	1	2	2	2	3	3	
Coil	Row	4	4	4	4	4	4	
	Max. working pressure	MPa	1.6	1.6	1.6	1.6	1.6	1.6
	Diameter	mm	Φ7.94	Φ7.94	Φ7.94	Φ7.94	Φ7.94	Φ7.94
Body	Net dimensions (WxHxD)	mm	628x455x200	858x455x200	1078x455x200	1078x455x200	1198x455x200	1198x551x200
	Packing size (WxHxD)	mm	895x595x300	1125x595x300	1345x595x300	1345x595x300	1465x595x300	1465x695x300
	Net weight	kg	12.6	15.3	18.7	18.7	21.3	24.8
	Gross weight	kg	16.9	20.8	25.4	25.4	28.1	31.9
Water inlet/outlet pipe	inch	Cold water: G3/4; Hot water: G1/2						
Drain pipe	mm	ODΦ18.5						

Notes:
 1. H: High fan speed; M: Medium fan speed; L: Low fan speed.
 2. Cooling conditions: Entering water 7°C, leaving water 12°C, Entering air temperature 27°C DB/19°C WB.
 Heating conditions: Entering water 65°C, leaving water 55°C, Entering air temperature 20°C DB/15°C WB.
 3. Noise is tested in a reverberation chamber test room.
 4. H3 series test with concealed tooling.

Dimensions

4-way cassette

2-pipe 4-way cassette
 Dimensions (unit:mm)

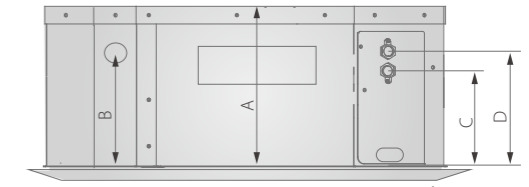
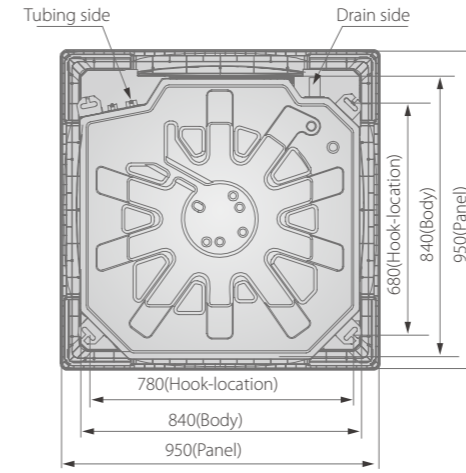

Model	A	B	C	D
MKA-600RA	230	170	135	185
MKA-750RA				
MKA-950RA				
MKA-1200RA	300	190	145	195
MAK-1500RA				

4-Pipe 4-way cassette
 Dimensions (unit:mm)

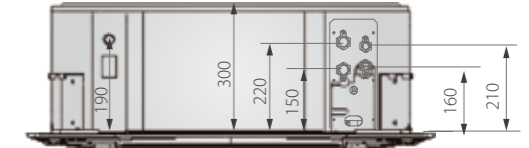
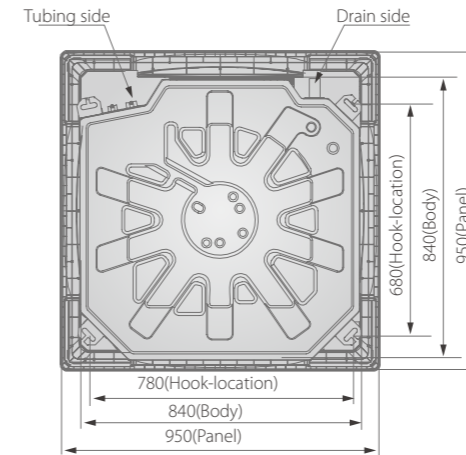

Service Spaces (unit:mm)

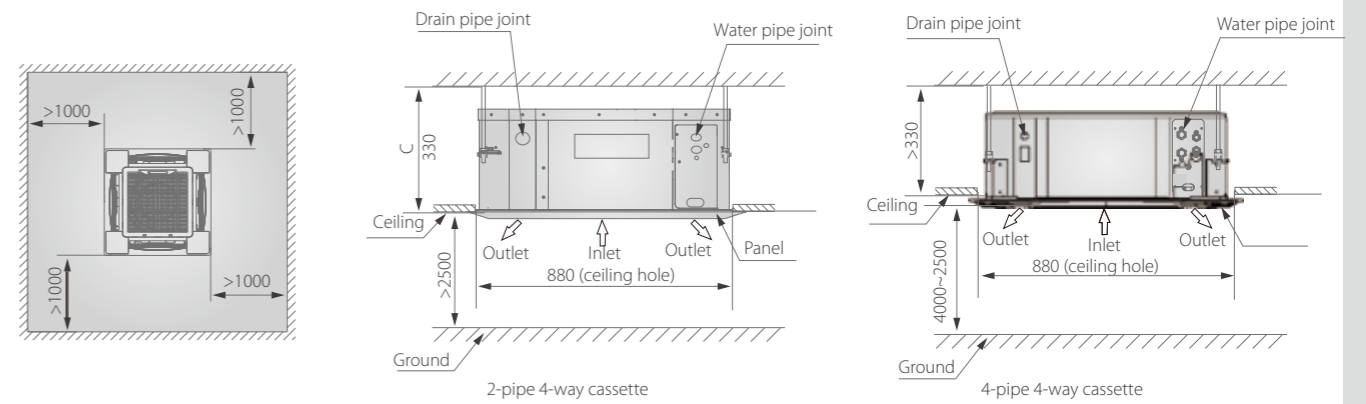

Compact 4-way cassette

2-pipe compact 4-way cassette
Dimensions (unit: mm)

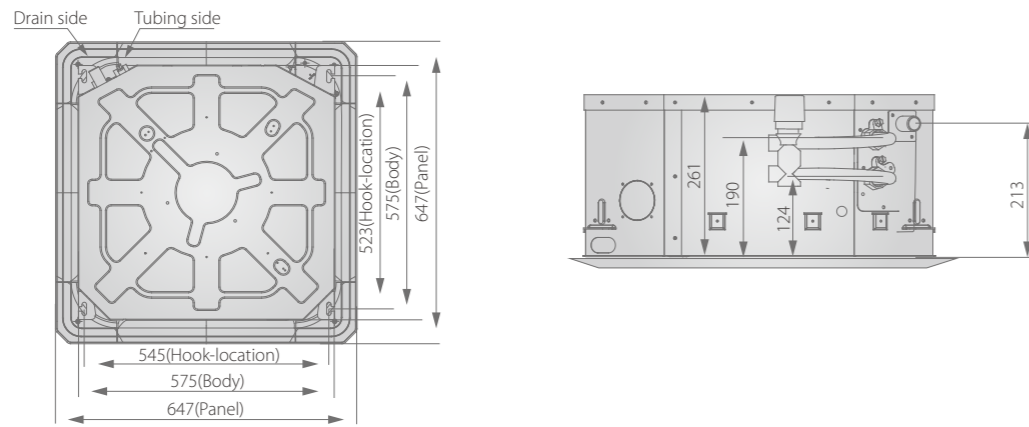

4-pipe compact 4-way cassette
Dimensions (unit: mm)

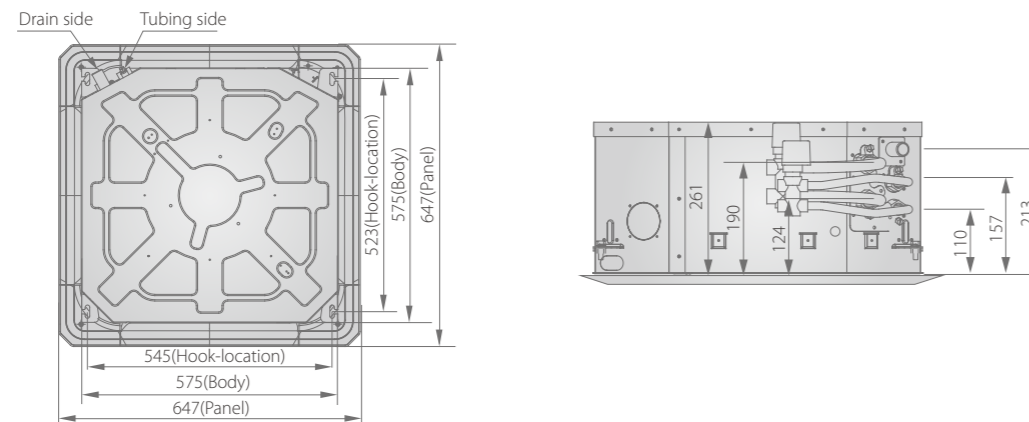

Service Space (unit: mm)

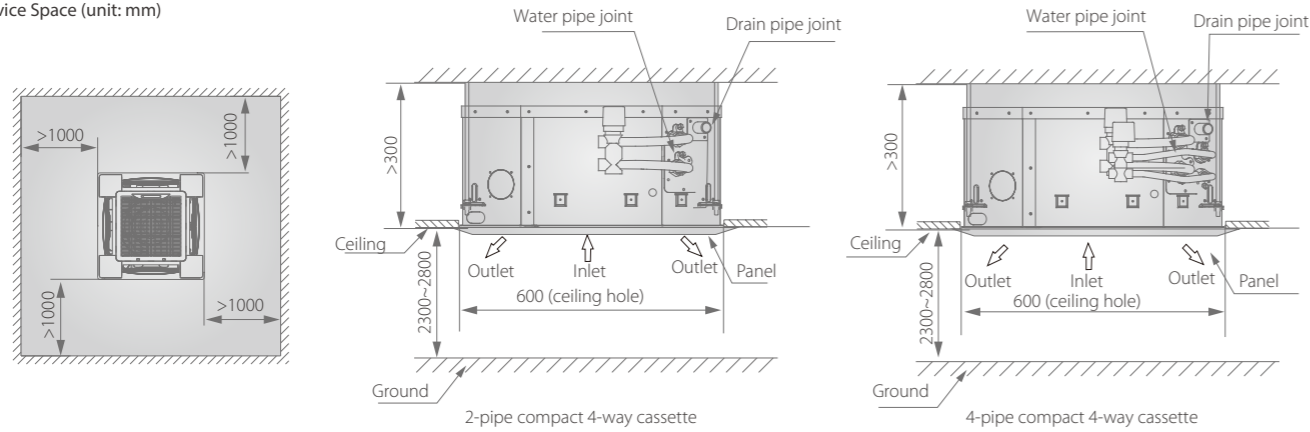

Thickness of the front panel

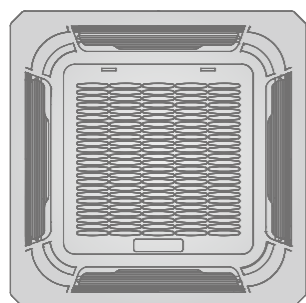

Type	H (mm)
4-way cassette	45
Compact 4-way cassette	50

1-way cassette

Dimensions (unit: mm)
MKC-300R-B MKC-400R-B

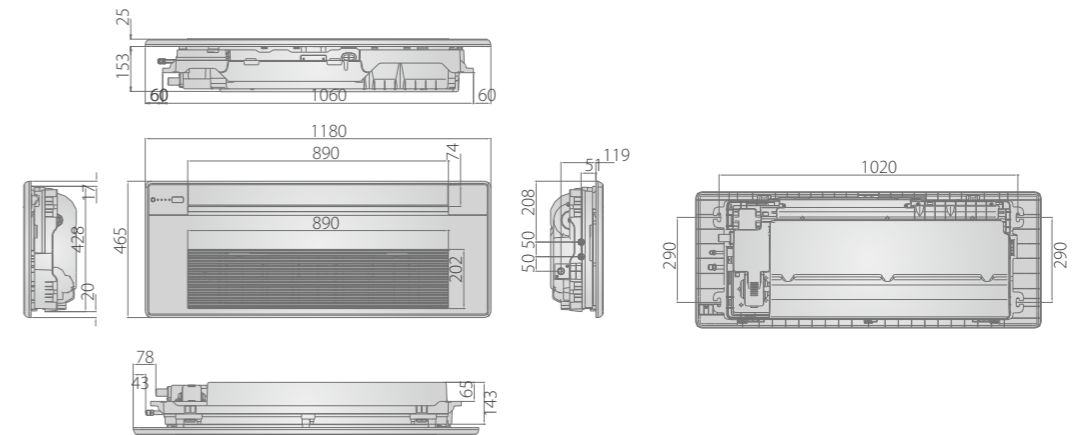

Wall mounted - A type

Dimensions (unit: mm)

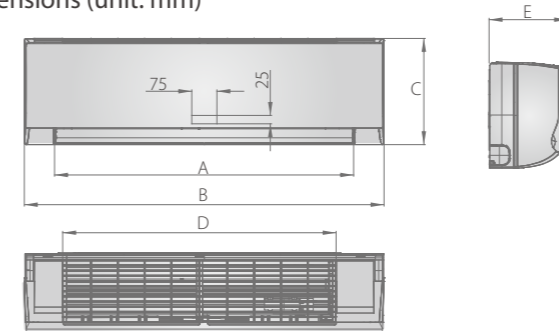

Model	MKG-250-C MKG-300-C MKG-400-C	MKG-500-C MKG-600-C
Size A	732	892
Size B	915	1072
Size C	290	315
Size D	663	813
Size E	233	237

Wall mounted - P type

Dimensions (unit: mm)

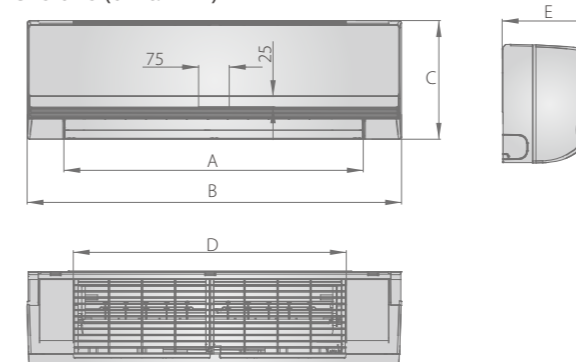

Model	MKG-250-D MKG-300-D MKG-400-D	MKG-500-D MKG-600-D
Size A	732	892
Size B	915	1072
Size C	290	315
Size D	663	813
Size E	229	232

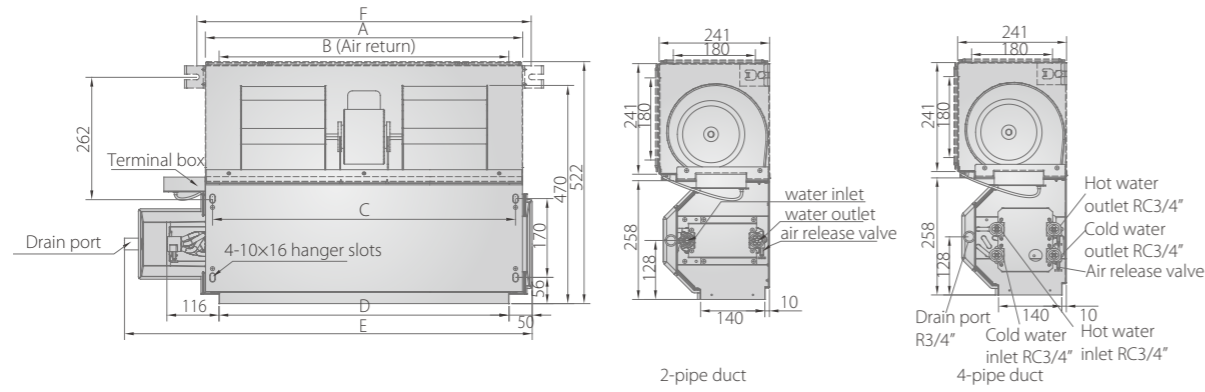

Size	A	B	C	D	E	F
200CFM	545	485	513	485	741	583
300CFM	645	585	613	585	841	683
400CFM	745	685	713	685	941	783
500CFM	745	685	713	685	941	783
600CFM	965	905	933	905	1161	1003
800CFM	1265	1205	1233	1205	1461	1303
1000CFM	1370	1310	1338	1310	1566	1408
1200CFM	1660	1600	1628	1600	1856	1698
1400CFM	1826	1766	1794	1766	2022	1864

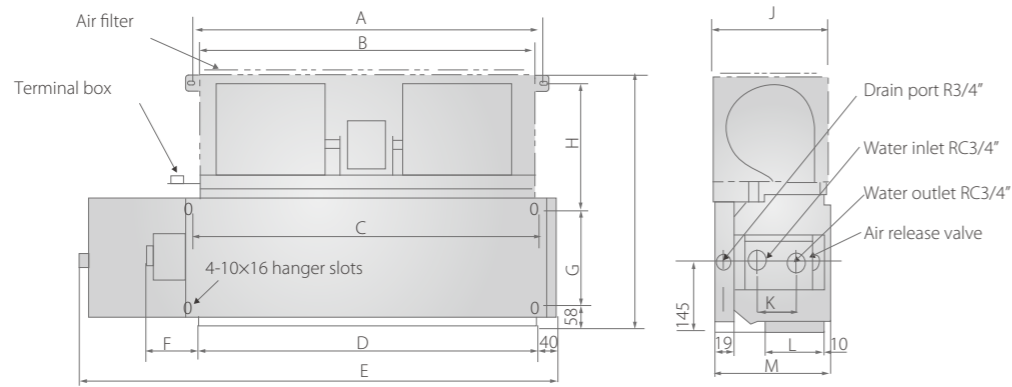

Notes:
 This figure is for reference only, actual product may differ.
 The dotted line in the figure is the dimension for air return plenum.
 Units with air return plenum is standard, units without air return plenum can be customized.

Size	Model	MKT3-800/1000G50-A4 MKT4-800/1000G50-A4	MKT4-1200/1400/ 1500/1600G50-A4	MKT4-1800/ 2000G50-A4
A		960	1085	1277
B		900	1135	1327
C		910	1112	1308
D		885	1085	1277
E		1180	1369	1500
F		150	160	160
G		195	195	195
H		335	335	335
I		612	612	612
J		342	342	342
K		231	231	231
L		230	230	230
M		340	340	340

MKS3(C) series

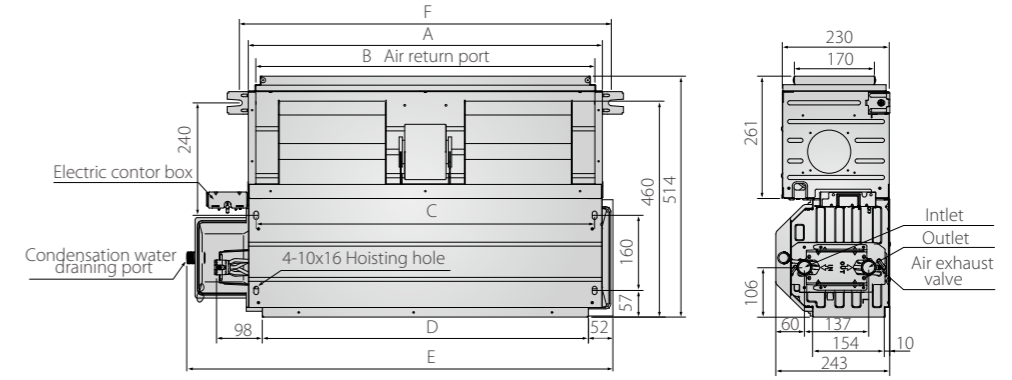

Size	Model	200	300	400/500	600	700	800/1000	1200	1400
A		475	620	755	850	1025	1215	1505	1745
B		443	588	723	818	993	1183	1473	1713
C		442	587	722	817	992	1182	1472	1712
D		415	560	695	790	965	1155	1445	1685
E		632	773	908	1003	1178	1368	1658	1898
F		513	658	793	888	1063	1253	1543	1783

MKT3(C) series

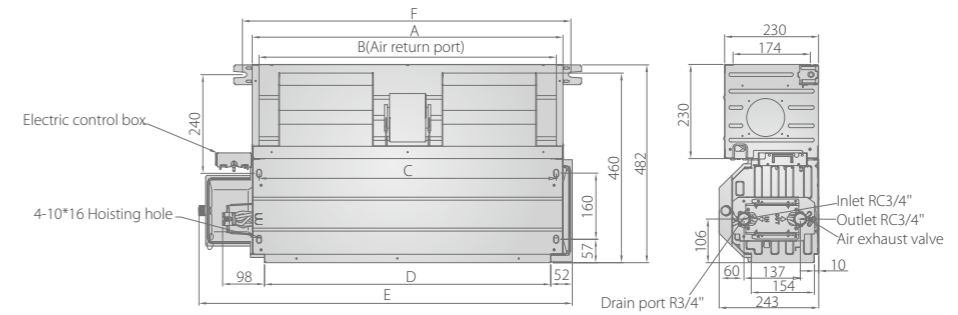

Size	Model	200-Model	300-Model	400-Model 500-Model	600-Model	700-Model	800-Model 1000-Model	1200-Model	1400-Model
A		475	620	755	850	1025	1215	1505	1745
B		443	588	723	818	993	1183	1473	1713
C		442	587	722	817	992	1182	1472	1712
D		415	560	695	790	965	1155	1445	1685
E		632	773	908	1003	1178	1368	1658	1898
F		513	658	793	888	1063	1253	1543	1783

High static pressure duct

Dimensions (unit:mm)

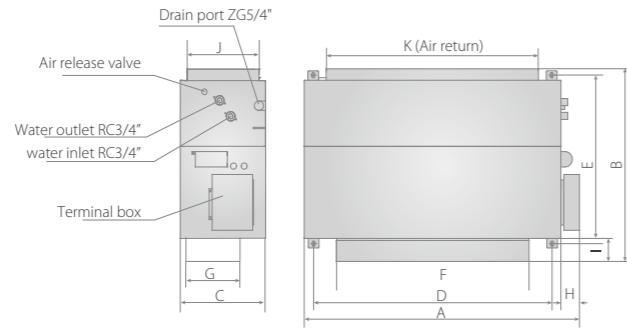

Size \ Model	MKT3H-800G70A MKT3H-1000G70A MKT3H-1200G70A MKT3H-1400G70A	MKT3H-800EG70A MKT3H-1000EG70A MKT3H-1200EG70A MKT3H-1400EG70A	MKT3H-1600G100A MKT3H-1800G100A MKT3H-2200G100A	MKT3H-1600EG100A MKT3H-1800EG100A MKT3H-2200EG100A
A	946	946	1290	1290
B	816	876	809	874
C	400	400	400	400
D	778	778	1118	1118
E	767	767	765	765
F	306	306	900	900
G	219	219	249	249
H	88	88	88	88
I	37	97	39	104
J	338	338	320	320
K	512	512	995	995

2nd generation Ceiling&Floor

Dimensions (unit: mm)

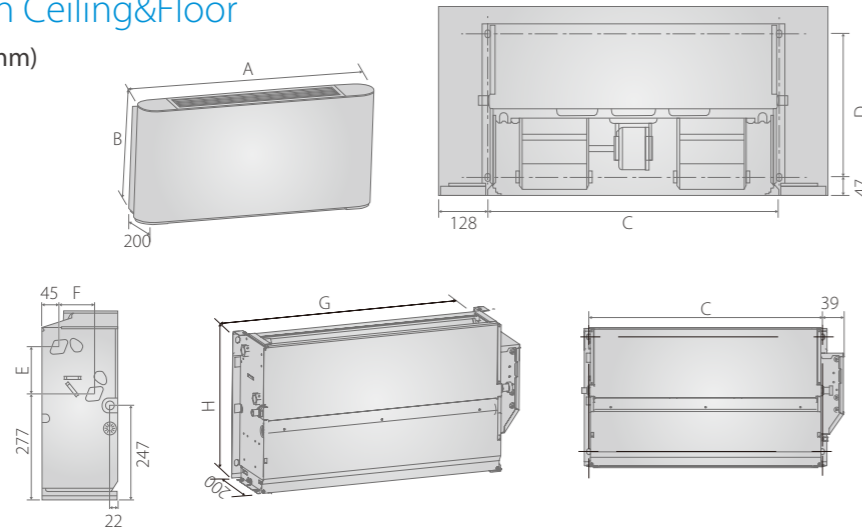

Model	150	250	350	500	700	800
A(mm)	790	1020	1240	1240	1360	1360
B(mm)	495	495	495	495	495	591
C(mm)	534	764	984	984	1104	1104
D(mm)	375	375	375	375	375	319
E(mm)	123	123	123	123	123	219
F(mm)	93	93	93	93	93	102
G(mm)	596	826	1046	1046	1166	1166
H(mm)	455	455	455	455	455	551

1-way cassette

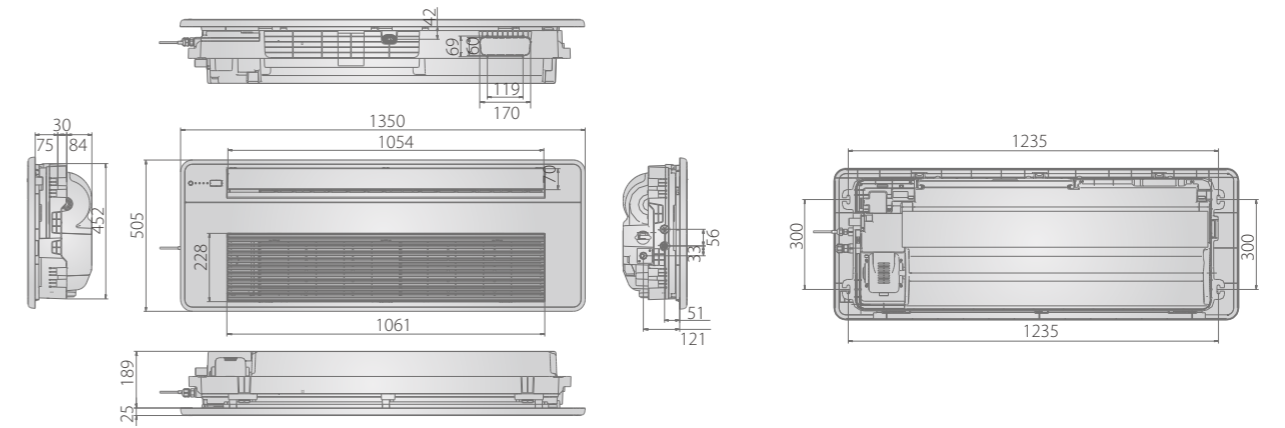

MKC-V400R-B
MKC-V600R-B

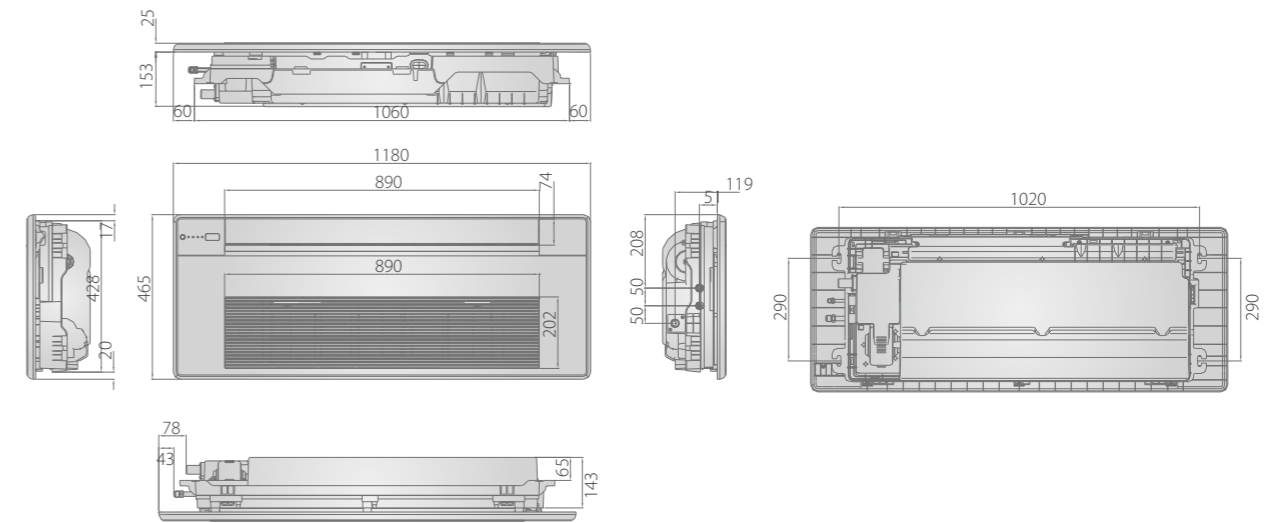

MKC-V300R-B

4-way cassette

2-pipe 4-way cassette

Dimensions (unit:mm)

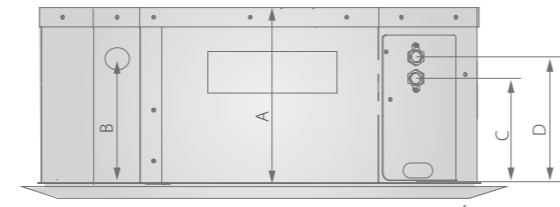
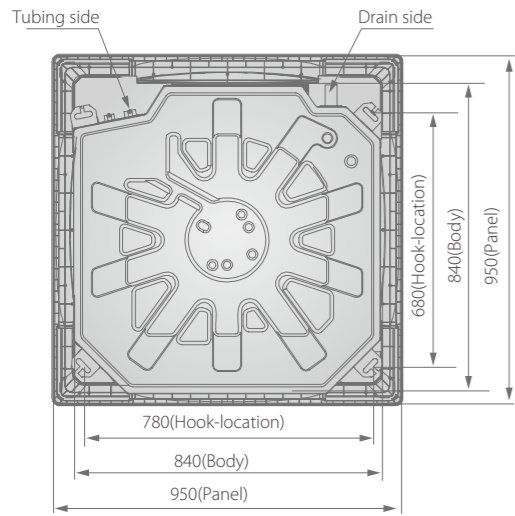

Model	Size	A	B	C	D
MKA-V600R		230	170	135	185
MKA-V750R					
MKA-V850R					
MKA-V950R					
MKA-V1200R		300	190	145	195
MAK-V1500R					

4-Pipe 4-way cassette

Dimensions (unit:mm)

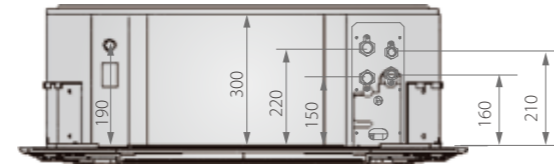
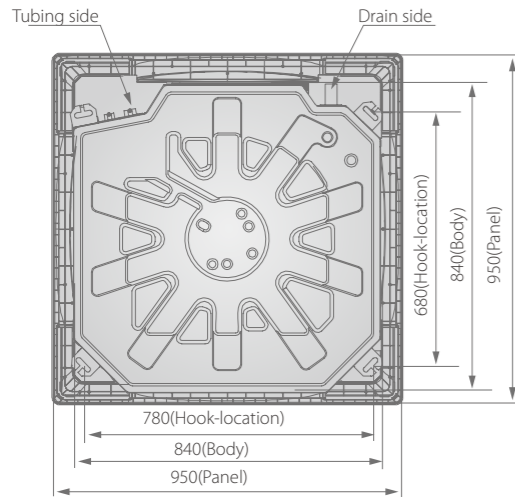

Service Spaces (unit:mm)

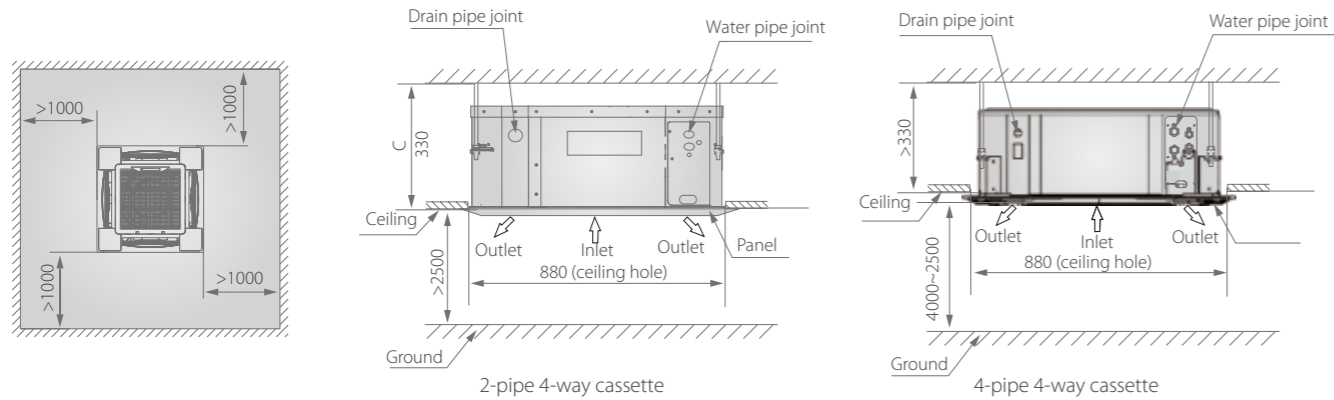

New 4-way cassette

Tubing side

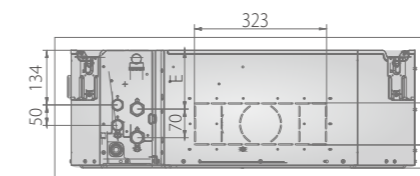
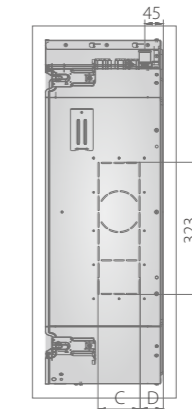
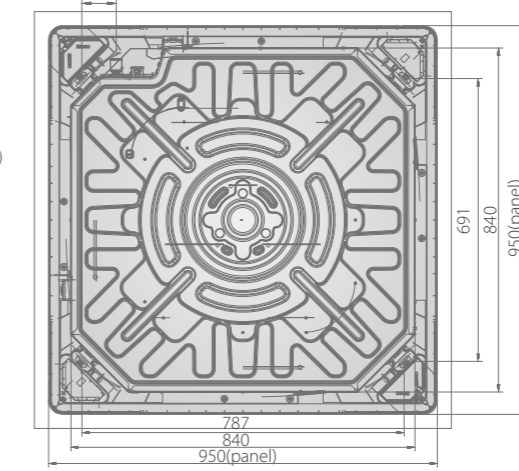
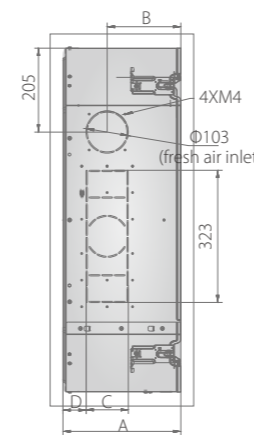
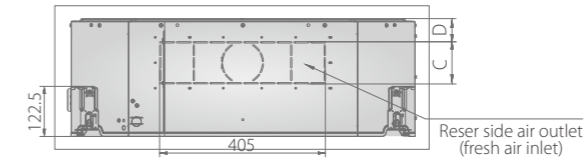
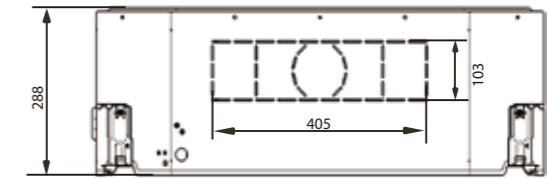
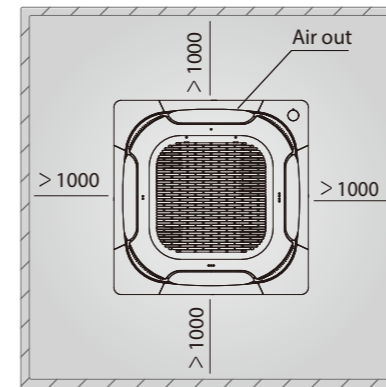
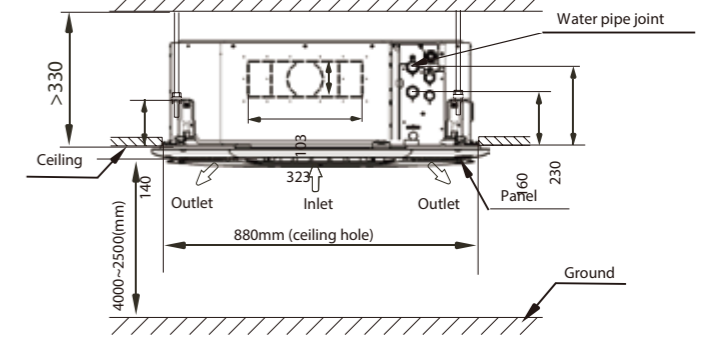
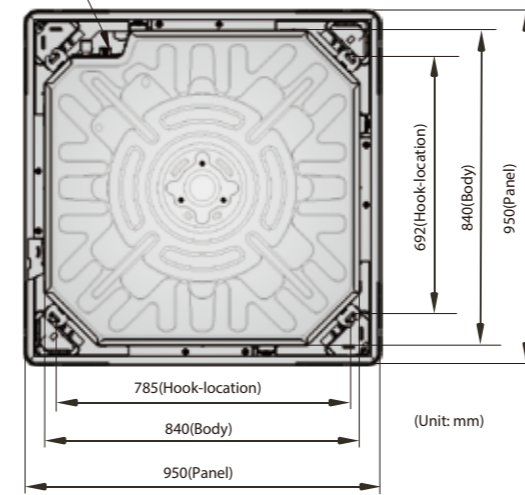

Model	Size(mm)	A	B	C	D	E
06C		204	141	63	41.5	69
07C-12C 06FC-12FC		288	90	103	56.5	144

Compact 4-way cassette

2-pipe compact 4-way cassette
Dimensions (unit: mm)

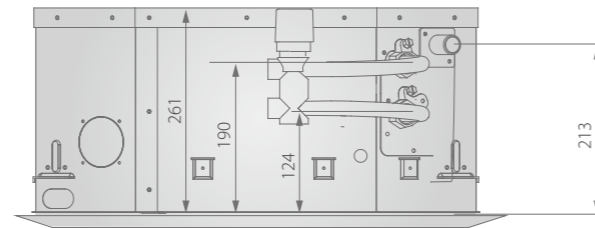
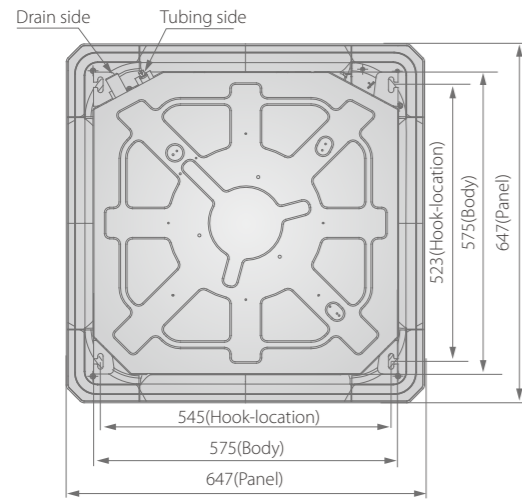

4-pipe compact 4-way cassette
Dimensions (unit: mm)

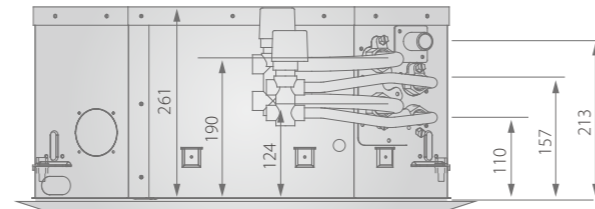
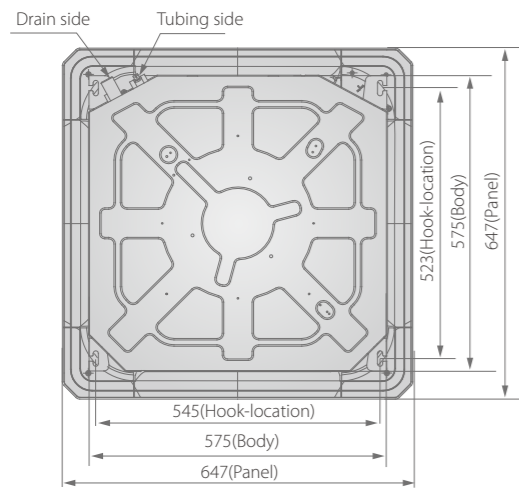

Service Spaces (unit: mm)

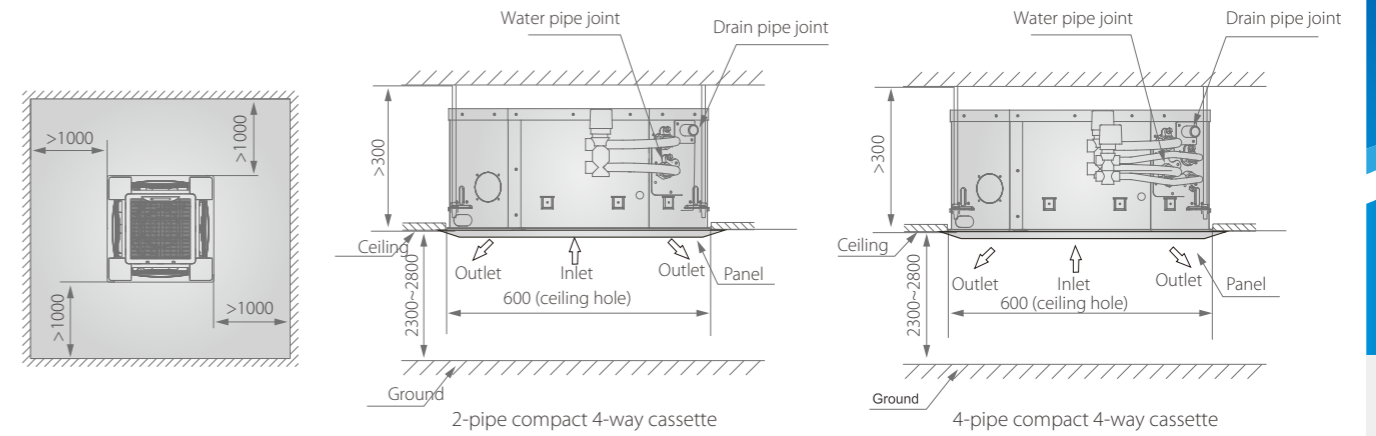

Height of the front panel

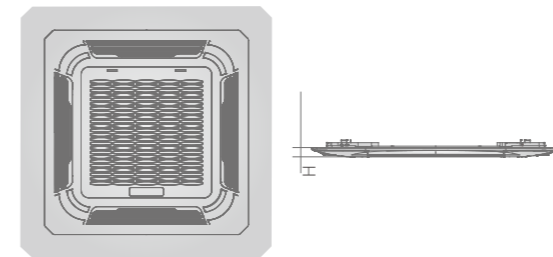

Type	H (mm)
4-way cassette	45
Compact 4-way cassette	50

Wall mounted - A type

Dimensions (unit: mm)

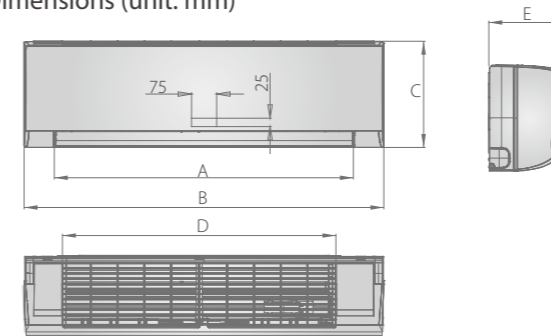

Model	MKG-V250C MKG-V300C MKG-V400C	MKG-V500C MKG-V600C
Size A	732	892
Size B	915	1072
Size C	290	315
Size D	663	813
Size E	233	237

Wall mounted - P type

Dimensions (unit: mm)

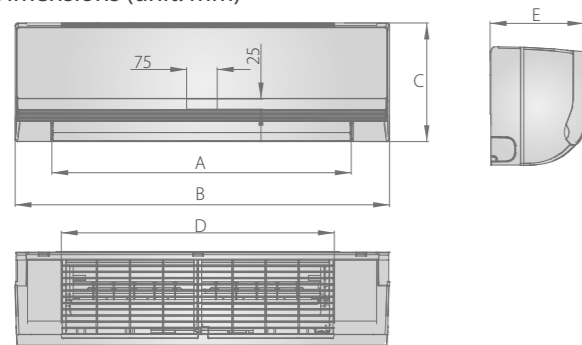

Model	MKG-V250D MKG-V300D MKG-V400D	MKG-V500D MKG-V600D
A	732	892
B	915	1072
C	290	315
D	663	813
E	229	232

Duct

Dimensions (unit: mm)

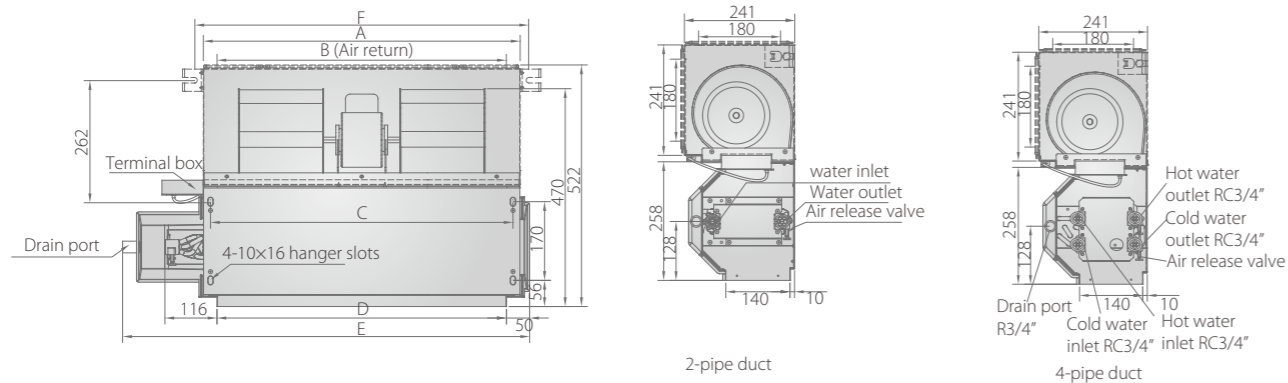

Size	A	B	C	D	E	F
200CFM	545	485	513	485	741	583
300CFM	645	585	613	585	841	683
400CFM	745	685	713	685	941	783
500CFM	745	685	713	685	941	783
600CFM	965	905	933	905	1161	1003
800CFM	1265	1205	1233	1205	1461	1303
1000CFM	1370	1310	1338	1310	1566	1408
1200CFM	1660	1600	1628	1600	1856	1698

MKT3(C) series

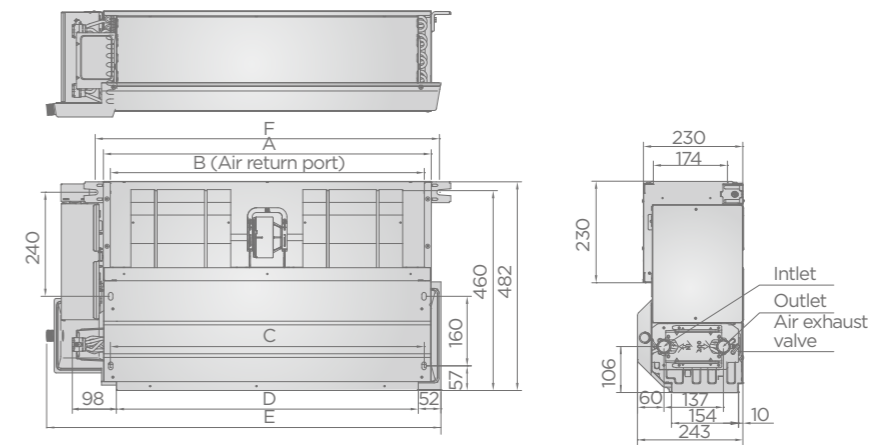

Model	200-Model	300-Model	400-Model 500-Model	600-Model	700-Model	800-Model 1000-Model	1200-Model	1400-Model
A	475	620	755	850	1025	1215	1505	1745
B	443	588	723	818	993	1183	1473	1713
C	442	587	722	817	992	1182	1472	1712
D	415	560	695	790	965	1155	1445	1685
E	632	773	908	1003	1178	1368	1658	1898
F	513	658	793	888	1063	1253	1543	1783

2nd generation Ceiling&Floor

Dimensions (unit: mm)

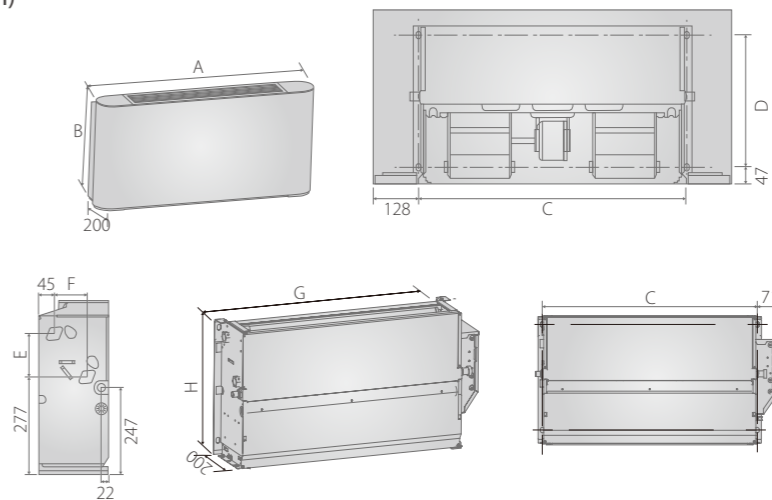

Model	150	250	350	500	700	800
A(mm)	790	1020	1240	1240	1360	1360
B(mm)	495	495	495	495	495	591
C(mm)	534	764	984	984	1104	1104
D(mm)	375	375	375	375	375	319
E(mm)	123	123	123	123	123	219
F(mm)	93	93	93	93	93	102
G(mm)	628	858	1078	1078	1198	1198
H(mm)	455	455	455	455	455	551

CONTROL SOLUTIONS

Midea CAC provides a variety of control schemes:

Embedded wall-mounted comes with standard remote controller. Similarly the other models have their respective series of controllers. The units can also be made to connect with BMS systems by undergoing some customizations.

- ▶ Control Devices
- ▶ Accessories
- ▶ Application of Central Control & BMS Control
- ▶ AC Selection Software
- ▶ DC Selection Software







FCU-KIT Functions

Functions			FCUKZ-01	FCUKZ-02	FCUKZ-03-B	FCUKZ-04-B
Control Customization	Follow me	With the follow me function, the indoor unit responds to the temperature measured by the temperature sensor built-in the wireless remote controller.	×	×	×	×
	Anti cold air	Prevent the unit from cold supply air when starting in winter.	●	●	●	●
	Auto-restart	The unit restarts automatically with the previous settings after power failure	●	●	●	●
	Forced fan running	After reaching the set temperature, the valve body closes and the fan operates according to the setting.	√	√	√	√
	Heat	Only electric auxiliary heating.	√	√	√	√
	Temperature compensation	Heating mode: $T_2=T_1+\Delta T$; Cooling mode: $T_2=T_1-\Delta T$ T2: Indoor Temperature, T1: Setting Temperature, ΔT : Temperature Compensation	√	√	√	√
	XYE Port	Communicate with central controllers or BMS.	●	●	●	●
	PQE Port	Communicate with Modbus.	○	○	○	○
	CCM18/CCM08/ CCM15/BMS/IMM	Central controllers and BMS.	●	●	●	●
	0-10V output control	By outputting a 0-10 V level, the opening of the valve body is controlled to meet different energy requirements.	×	×	×	×
	0-10V input control	By inputting a 0- 10 V level to PCB, the fan motor speed is controlled to meet different energy requirements.	×	×	×	×
Display board	-	●	●	●	●	







Note:
 ●: equipped as standard; ○: customization option; ×: without this function; √: switch setting

Control Devices



Wireless Remote Controllers

Model	Appearance	Function Descriptions	Applicable FCUs
R05/BGE		<ul style="list-style-type: none"> ● LCD display screen ● Mode control 	4-way Cassette (standard) 1-way Cassette (standard)
R51/E		<ul style="list-style-type: none"> ● Fan speeds control ● Time setting / Temp. setting / Swing setting 	Compact 4-way cassette (standard) Wall-mounted (standard)
RM12F		<ul style="list-style-type: none"> ● Display panel (Digital Tube) off 	Wall-mounted (standard)
		<ul style="list-style-type: none"> ● Individual louver control 	4-way Cassette (standard)
RM12		<ul style="list-style-type: none"> ● Customized on the basis of RM12F 	New 4-way Cassette (optional)

Wired Controllers

Model	Appearance	Function Descriptions	Applicable FCUs
KJR-18B/E		<ul style="list-style-type: none"> ● Mechanical thermostat ● Mode control ● Fan speeds control ● Temp. setting 	AC Ceiling& Floor and Duct without electric heater (optional)
KJR-29B		<ul style="list-style-type: none"> ● Receiving remote signal ● Mode control ● Fan speeds control ● Temp. setting 	AC Cassette / Wall-mounted (optional) DC Cassette / Wall-mounted (optional)
KJR-75A/BK		<ul style="list-style-type: none"> ● LED display screen ● Mode control ● Seven speed fan control ● Temp. setting 	DC 2nd generation Ceiling&Floor(optional) DC one-way cassette (optional)
KJRP-86I/MFK-E		<ul style="list-style-type: none"> ● LCD display screen ● Mode control ● Fan speeds control ● Timer / Temp. setting ● ECO setting/reminder 	AC Ceiling& Floor and AC&DC Duct without electric heater (optional)
KJRP-86A/BMFNKD-E		<ul style="list-style-type: none"> ● LCD display screen with backlight ● Mode/Electric heater control ● Fan speeds control ● Timer / Temp. setting ● ECO setting/reminder ● Compatible with Modbus 	AC Ceiling& Floor and AC&DC Duct (optional)
WDC3-86S		<ul style="list-style-type: none"> ● Bi-directional Communication ● Buzzer Sound On/Off ● Group Control ● Main or Secondary Controller Setting ● 2 Permission Levels ● Humidity Setting 	MK-CBS series DC duct (optional) New 4-way Cassette (optional)

Centralized Controllers

Model	Appearance	Function Descriptions	Applicable FCUs
CCM09		<ul style="list-style-type: none"> ● Weekly schedule function ● Large LCD display screen ● Max. of 64 FCUs can be controlled by a CCM09 ● Mode control / fan speed control ● Time setting / temp. setting / swing setting 	All FCUs except MK-CBS series DC duct (AC 1-way cassette FCUs need adding NIM01 module, non-PCB FCUs need adding PC board control kit)
CCM30		<ul style="list-style-type: none"> ● Touch-style keys ● Large LCD display screen ● Max. of 64 FCUs can be controlled by a CCM30 ● Mode control / fan speed control ● Time setting / temp. setting / swing setting 	All FCUs (AC 1-way cassette FCUs need adding NIM01 module, non-PCB FCUs need adding PC board control kit)

Accessories

PC Board Control Kit for FCU



- Available for all non-PCB FCUs.
- Flexibility installation: can be attached to the unit, mounted on a wall or hung under a ceiling.
- External installation making maintenance more convenient.
- Functions: three fan speeds control, Water pump control, Long-distance ON/OFF control, ALARM function, electric heater control.
- Operating status can be displayed by wired controller lamp indicator.
- Centralized control function.
- BMS control function through Modbus protocol.

Centralized control

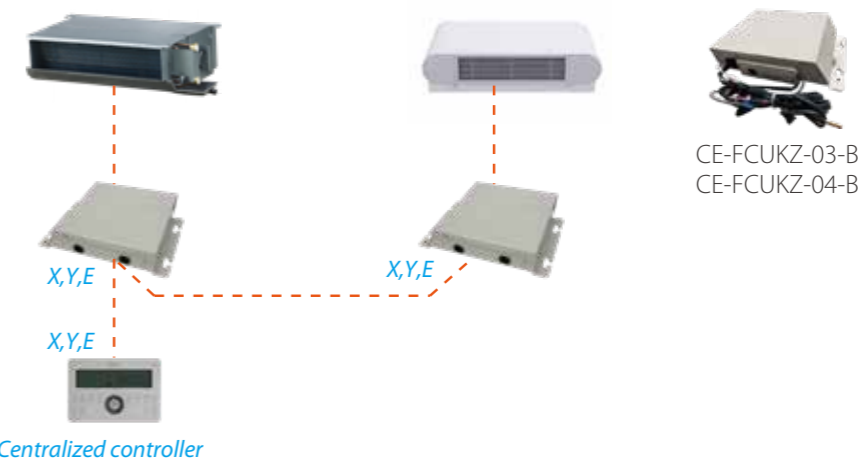

Note: The ceiling&floor of AC and duct series of AC and DC need PCB kit to connect Centralized controller.

Model	CE-FCUKZ-01	CE-FCUKZ-02
Applicable appliance	2-pipe FCUs	4-pipe FCUs
Power supply	V-Ph-Hz 220~240-1-50/60	
Operation range	Room temp.	°C 17-30
	Inlet water temp.	°C 3-75
Temp. controlling precision	°C ±1	
Net dimension	WxHxD mm	310x76x290
Packing size	WxHxD mm	384x174x359
Net weight	kg 2.5	
Gross weight	kg 4.6	

Model	CE-FCUKZ-03-B	CE-FCUKZ-04-B
Applicable appliance	2-pipe FCUs	4-pipe FCUs
Power supply	V-Ph-Hz 220~240-1-50/60	
Operation range	Room temp.	°C 17-30
	Inlet water temp.	°C 3-75
Temp. controlling precision	°C ±1	
Net dimension	WxHxD mm	308x80x244
Packing size	WxHxD mm	517x140x319
Net weight	kg 2.3	
Gross weight	kg 3.6	

Network Module

- Achieve centralized control through XYE connection.
- Only available for one way Cassette of AC.
- Address setting should be same as connecting FCU.
- There LEDs display: operation indicator lamp, communication indicator lamp and malfunction indicator lamp.



Central wiring

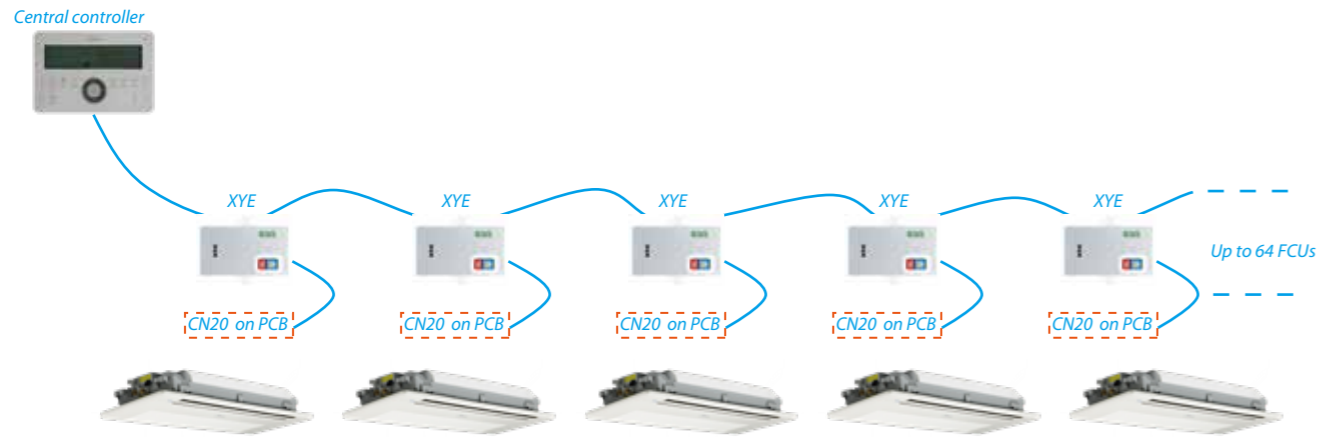

Valve kit



DN(mm)	Inner Screw Thread	Applicable Appliance
15	1/2"	For 4-pipe cassette and ceiling&floor (for hot water).
20	3/4"	For 2-pipe FCU,4-pipe duct, 4-pipe cassette and ceiling&floor (for cold water).

Note:
The valve kit includes valve, actuator and connecting pipe. For different model of units, the models of valve kit are difference.

Application of Central Control & BMS Control

AC Series

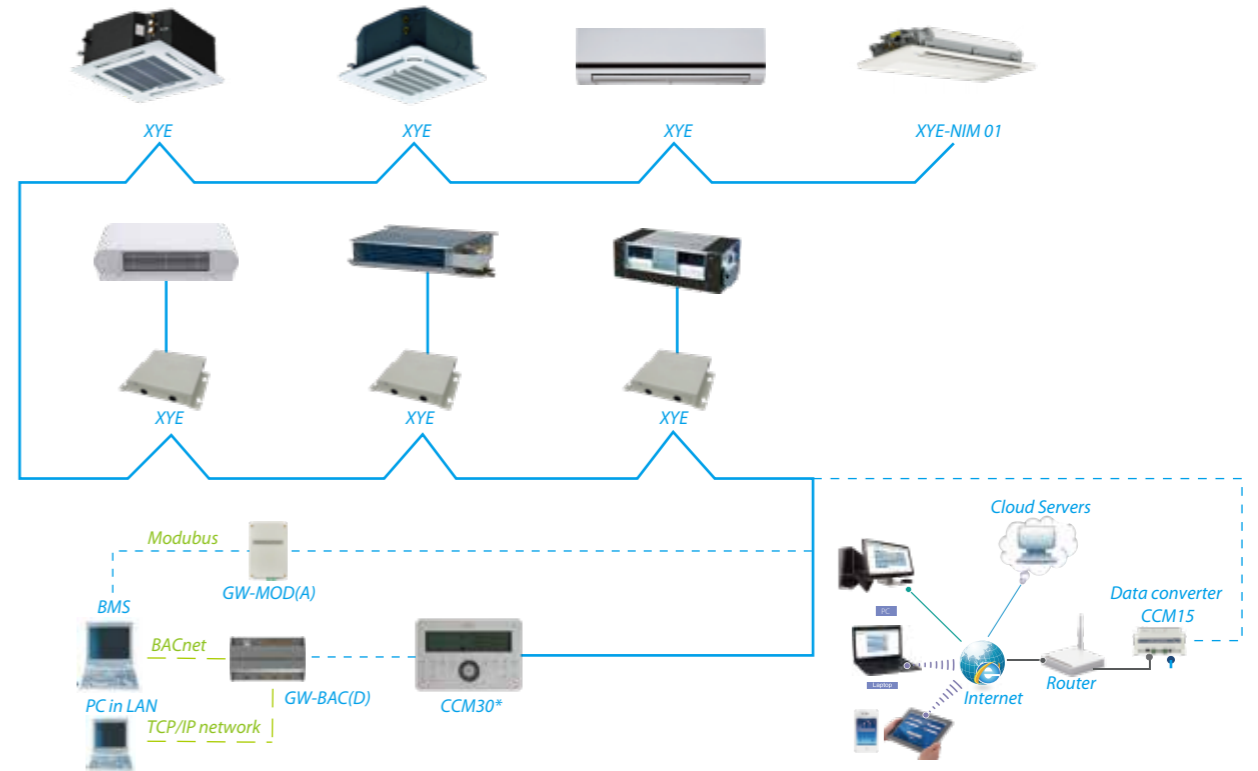

DC Series

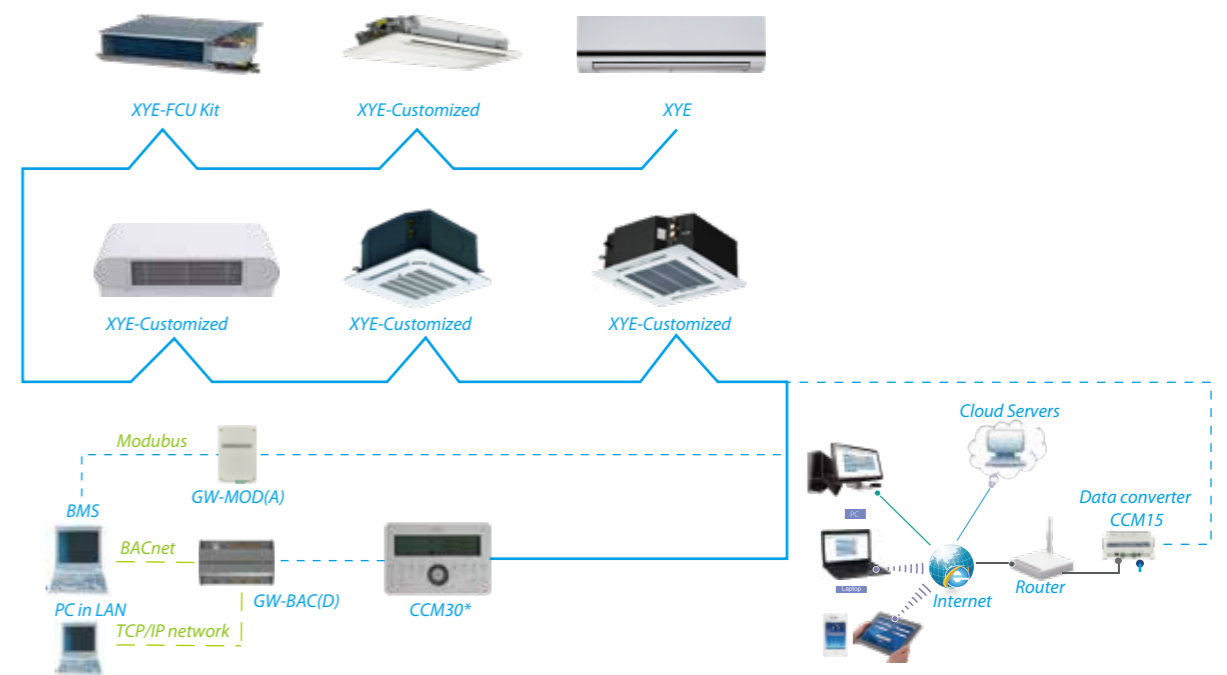

*Note: When connecting to BMS through the BACnet protocol gateway, a customized version of CCM30 is required.

Features

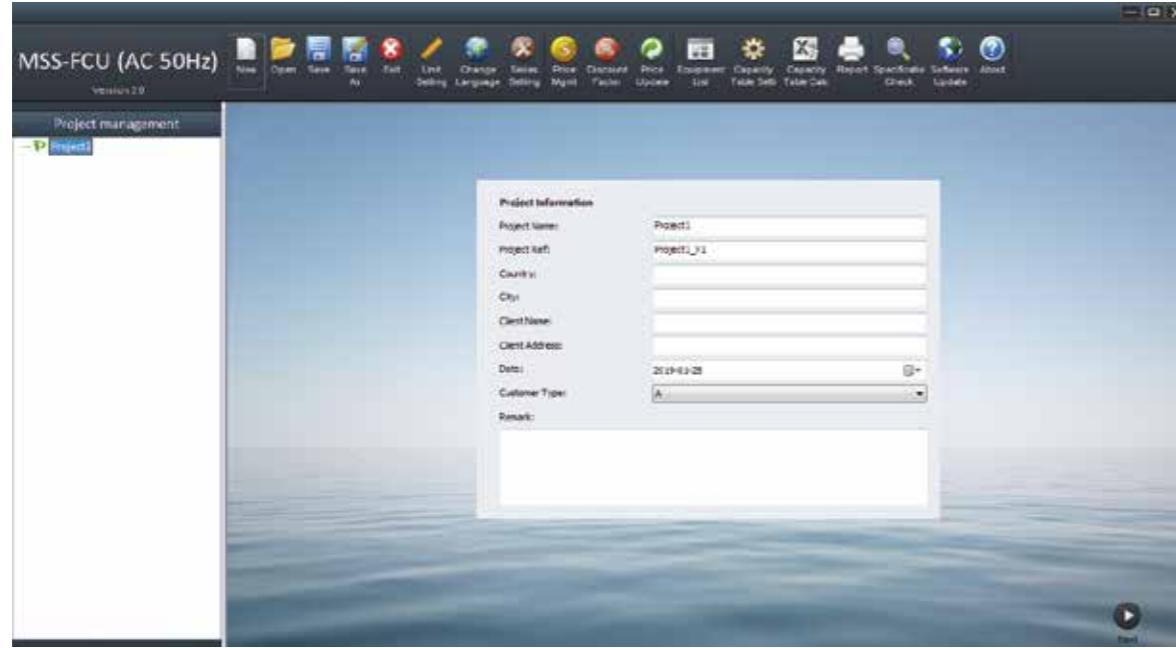

- Select by entering air and water conditions as well as fan speed.
- Easy to operate interface and visual display.
- Powerful project management function.

Main Interface

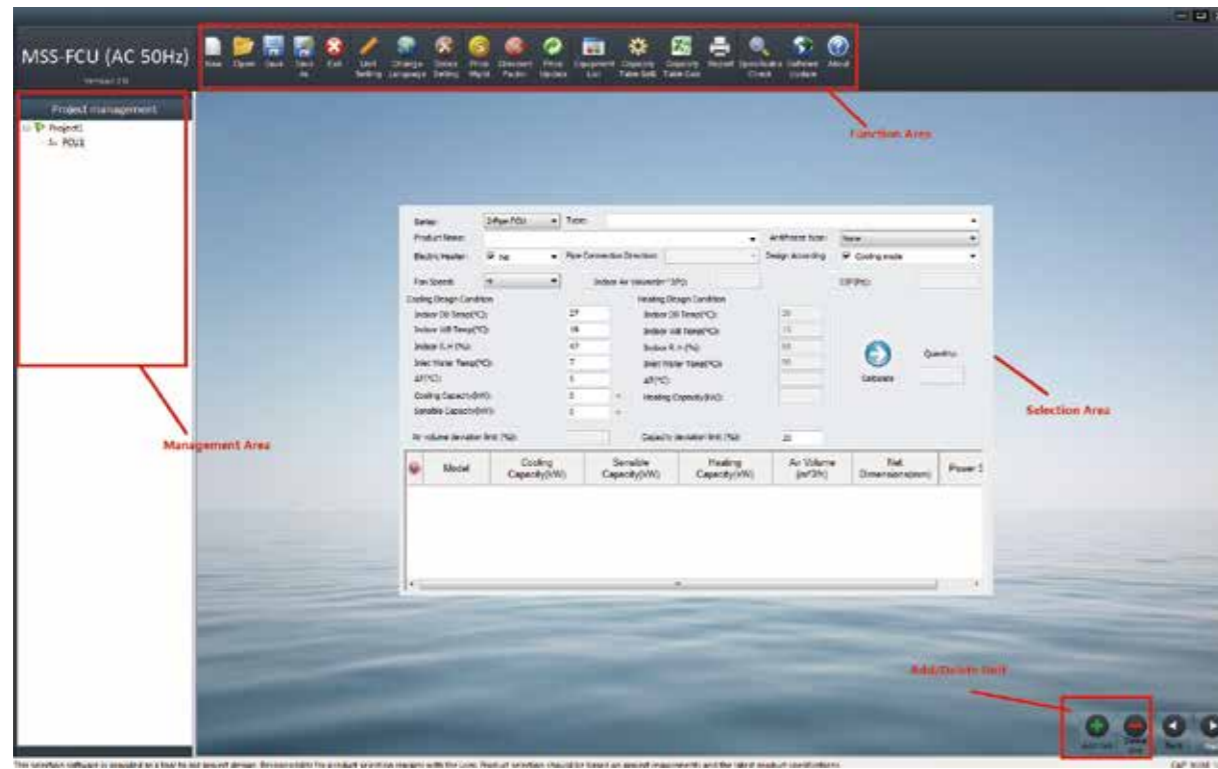

Selection Interface

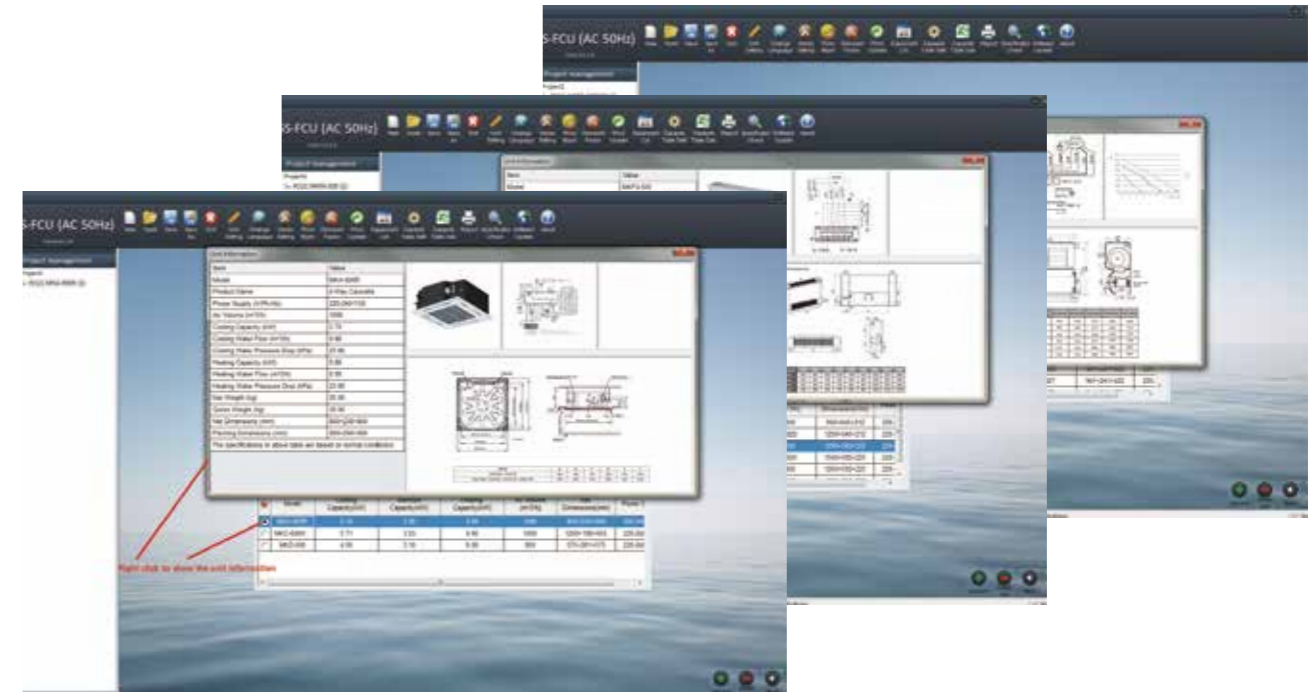

Report Data Interface

The screenshot displays the 'Report Data Interface' showing a detailed data table. The table is organized by indoor temperature (21.0, 23.0, 25.0, 27.0, 29.0) and outdoor temperature (15.0, 17.0, 19.0, 21.0, 23.0, 25.0, 27.0, 29.0). The columns represent various performance metrics such as Cooling Capacity (kW), Heating Capacity (kW), Air Volume (m³/h), and Power (kW).

EWT	OT	Indoor Temperature (DB)	MSS-FCU																			
			21.0				23.0				25.0				27.0				29.0			
[°C]	[°C]	[°C]	TC	DC	WF	WPD	TC	DC	WF	WPD	TC	DC	WF	WPD	TC	DC	WF	WPD	TC	DC	WF	WPD
15.0	15.0	15.0	3.72	2.78	1.97	20.29	4.94	3.94	3.33	40.27	4.62	3.13	3.37	48.84	4.82	3.12	3.37	48.42	4.88	3.11	3.31	47.98
17.0	17.0	17.0	4.68	3.18	3.34	49.73	4.94	3.94	3.33	40.27	4.62	3.13	3.37	48.84	4.82	3.12	3.37	48.42	4.88	3.11	3.31	47.98
19.0	19.0	19.0	5.66	3.56	3.62	79.18	5.64	3.57	3.32	63.84	5.63	3.59	3.31	69.01	5.62	3.58	3.30	68.51	5.69	3.58	3.30	47.98
21.0	21.0	21.0	6.66	3.96	3.71	79.61	5.94	3.93	3.31	79.23	6.36	3.39	3.31	77.86	6.34	3.39	3.31	77.48	6.32	3.40	3.31	77.10
23.0	23.0	23.0	7.66	4.36	3.75	75.12	6.34	4.35	3.30	63.84	6.76	3.39	3.30	63.48	6.74	3.39	3.30	63.10	6.72	3.40	3.30	62.72
25.0	25.0	25.0	8.66	4.76	3.79	60.64	6.74	4.75	3.29	40.65	7.16	3.29	3.29	40.28	7.14	3.29	3.29	40.00	7.12	3.30	3.29	40.00
27.0	27.0	27.0	9.66	5.16	3.83	46.16	7.14	5.15	3.28	25.41	7.56	3.28	3.28	25.04	7.54	3.28	3.28	24.76	7.52	3.29	3.28	24.76
29.0	29.0	29.0	10.66	5.56	3.87	31.68	7.54	5.55	3.27	10.25	8.42	3.27	3.27	10.00	8.40	3.27	3.27	9.72	8.38	3.28	3.27	9.72
15.0	15.0	15.0	3.98	2.98	2.75	15.12	4.98	2.97	2.74	25.41	4.41	3.00	2.99	25.18	4.39	2.99	2.99	24.95	4.37	2.99	2.99	24.71
17.0	17.0	17.0	4.48	3.02	2.96	25.84	4.43	3.01	2.76	25.41	4.41	3.00	2.99	25.18	4.39	2.99	2.99	24.95	4.37	2.99	2.99	24.71
19.0	19.0	19.0	5.48	3.45	3.11	26.67	5.44	3.47	2.75	25.05	5.43	3.49	3.11	26.42	5.42	3.48	3.11	26.29	5.40	3.49	3.11	26.05
21.0	21.0	21.0	6.48	3.87	3.24	43.84	6.43	3.28	2.74	40.65	6.42	3.29	3.24	40.48	6.41	3.29	3.24	40.26	6.39	3.29	3.24	40.00
23.0	23.0	23.0	7.48	4.27	3.28	30.16	7.43	4.27	2.73	25.41	7.42	4.28	3.28	25.24	7.41	4.28	3.28	25.00	7.39	4.29	3.28	24.76
25.0	25.0	25.0	8.48	4.67	3.32	15.84	8.43	4.67	2.72	10.25	8.42	4.68	3.32	10.00	8.41	4.68	3.32	9.76	8.39	4.69	3.32	9.72
27.0	27.0	27.0	9.48	5.07	3.36	1.16	9.43	5.07	2.71	3.90	9.42	5.08	3.36	3.90	9.41	5.08	3.36	3.66	9.39	5.09	3.36	3.66
29.0	29.0	29.0	10.48	5.47	3.40	13.36	10.43	5.47	2.70	3.25	10.42	5.48	3.40	13.00	10.41	5.48	3.40	12.76	10.39	5.49	3.40	12.72
15.0	15.0	15.0	3.98	2.98	2.75	15.12	4.98	2.97	2.74	25.41	4.41	3.00	2.99	25.18	4.39	2.99	2.99	24.95	4.37	2.99	2.99	24.71
17.0	17.0	17.0	4.48	3.02	2.96	25.84	4.43	3.01	2.76	25.41	4.41	3.00	2.99	25.18	4.39	2.99	2.99	24.95	4.37	2.99	2.99	24.71
19.0	19.0	19.0	5.48	3.45	3.11	26.67	5.44	3.47	2.75	25.05	5.43	3.49	3.11	26.42	5.42	3.48	3.11	26.29	5.40	3.49	3.11	26.05
21.0	21.0	21.0	6.48	3.87	3.24	43.84	6.43	3.28	2.74	40.65	6.42	3.29	3.24	40.48	6.41	3.29	3.24	40.26	6.39	3.29	3.24	40.00
23.0	23.0	23.0	7.48	4.27	3.28	30.16	7.43	4.27	2.73	25.41	7.42	4.28	3.28	25.24	7.41	4.28	3.28	25.00	7.39	4.29	3.28	24.76
25.0	25.0	25.0	8.48	4.67	3.32	15.84	8.43	4.67	2.72	10.25	8.42	4.68	3.32	10.00	8.41	4.68	3.32	9.76	8.39	4.69	3.32	9.72
27.0	27.0	27.0	9.48	5.07	3.36	1.16	9.43	5.07	2.71	3.90	9.42	5.08	3.36	3.90	9.41	5.08	3.36	3.66	9.39	5.09	3.36	3.66
29.0	29.0	29.0	10.48	5.47	3.40	13.36	10.43	5.47	2.70	3.25	10.42	5.48	3.40	13.00	10.41	5.48	3.40	12.76	10.39	5.49	3.40	12.72
15.0	15.0	15.0	3.98	2.98	2.75	15.12	4.98	2.97	2.74	25.41	4.41	3.00	2.99	25.18	4.39	2.99	2.99	24.95	4.37	2.99	2.99	24.71
17.0	17.0	17.0	4.48	3.02	2.96	25.84	4.43	3.01	2.76	25.41	4.41	3.00	2.99	25.18	4.39	2.99	2.99	24.95	4.37	2.99	2.99	24.71
19.0	19.0	19.0	5.48	3.45	3.11	26.67	5.44	3.47	2.75	25.05	5.43	3.49	3.11	26.42	5.42	3.48	3.11	26.29	5.40	3.49	3.11	26.05
21.0	21.0	21.0	6.48	3.87	3.24	43.84	6.43	3.28	2.74	40.65	6.42	3.29	3.24	40.48	6.41	3.29	3.24	40.26	6.39	3.29	3.24	40.00
23.0	23.0	23.0	7.48	4.27	3.28	30.16	7.43	4.27	2.73	25.41	7.42	4.28	3.28	25.24	7.41	4.28	3.28	25.00	7.39	4.29	3.28	24.76
25.0	25.0	25.0	8.48	4.67	3.32	15.84	8.43	4.67	2.72	10.25	8.42	4.68	3.32	10.00	8.41	4.68	3.32	9.76	8.39	4.69	3.32	9.72
27.0	27.0	27.0	9.48	5.07	3.36	1.16	9.43	5.07	2.71	3.90	9.42	5.08	3.36	3.90	9.41	5.08	3.36	3.66	9.39	5.09	3.36	3.66
29.0	29.0	29.0	10.48	5.47	3.40	13.36	10.43	5.47	2.70	3.25	10.42	5.48	3.40	13.00	10.41	5.48	3.40	12.76	10.39	5.49	3.40	12.72